



## Technical Data

Tugger train trolley



			Pallet trolley with corner guards	Pallet trolley with push bar	Table trolley	Rack trolley low	Rack trolley high
Total area load	Q	kg	1000	1000	1000	1000	1000
Load capacity, level 1/2/3/4	Q	kg	1000/-/-/-	1000/-/-/-	1000/500/-/-	1000/200/200/-	1000/200/200/200
Self-weight		kg	30	30	43	53	65
l <sub>1</sub>		mm	-	1151	1151	1102	1102
l <sub>2</sub>		mm	1220	1220	1220	1220	1220
l <sub>3</sub>		mm	1238	1300*	1300*	1455*	1455*
b <sub>1</sub>		mm	-	-	702	702	702
b <sub>2</sub>		mm	820	820	520	820	820
b <sub>3</sub>		mm	838	-	-	-	-
h <sub>1</sub>		mm	313	313	313	313	313
h <sub>2</sub>		mm	-	-	933	763	763
h <sub>3</sub>		mm	-	-	-	1213	1213
h <sub>4</sub>		mm	-	-	-	-	1663
h <sub>5</sub>		mm	365	1011	1011	1403	1814
ø Wheel		mm	200	200	200	200	200

\* incl. Push bar

Pallet trolley  
with corner guards

Pallet trolley  
with push bar

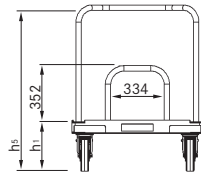
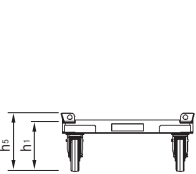
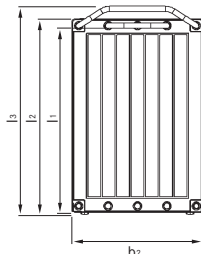
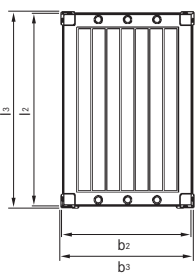
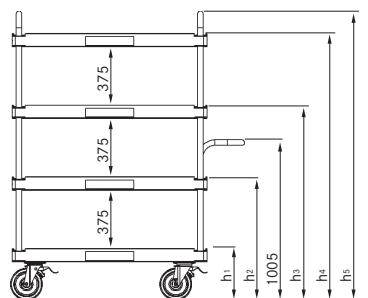
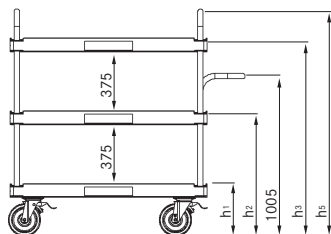
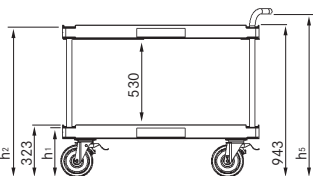
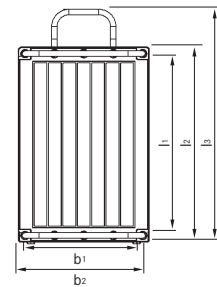
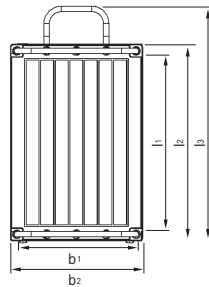
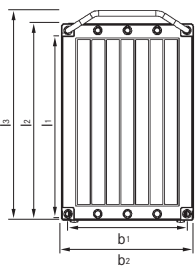

Table trolley

Rack trolley, low

Rack trolley, high



			Pallet trolley with corner guards	Pallet trolley with push bar	Table trolley	Rack trolley low	Rack trolley high
Total area load	Q	kg	500	500	500	500	500
Load capacity, level 1/2/3/4	Q	kg	500/-/-/-	500/-/-/-	500/375/-/-	500/150/150/-	500/150/150/-
Self-weight		kg	17	19	26	30	36
l <sub>1</sub>		mm	-	840	840/810	810	810
l <sub>2</sub>		mm	904	904	904	904	904
l <sub>3</sub>		mm	904	964	964	-	-
b <sub>1</sub>		mm	-	-	-	-	-
b <sub>2</sub>		mm	602	602	602	602	602
b <sub>3</sub>		mm	-	-	-	-	-
h <sub>1</sub>		mm	287	287	287	287	287
h <sub>2</sub>		mm	-	-	900	737	737
h <sub>3</sub>		mm	-	-	-	1187	1187
h <sub>4</sub>		mm	-	-	-	-	1637
h <sub>5</sub>		mm	297	1040	1040	1394	1805
ø Wheel		mm	200	200	200	200	200

\* incl. Push bar

Pallet trolley  
with corner guards

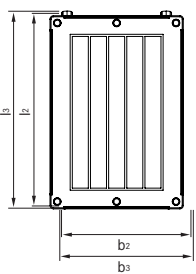

Pallet trolley  
with push bar

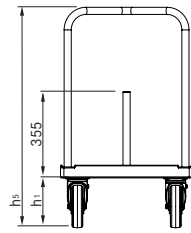
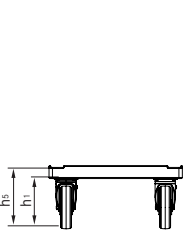
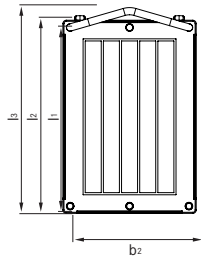
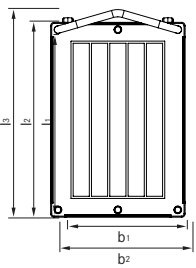
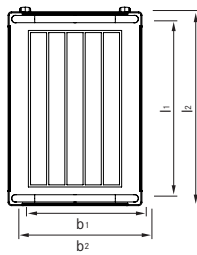

Table trolley



Rack trolley, low



Rack trolley, high

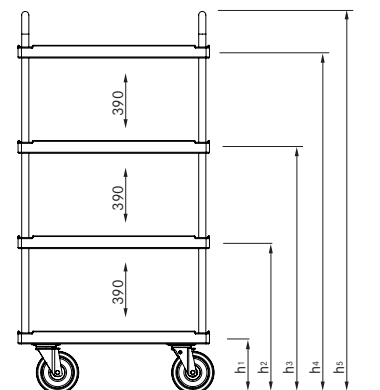
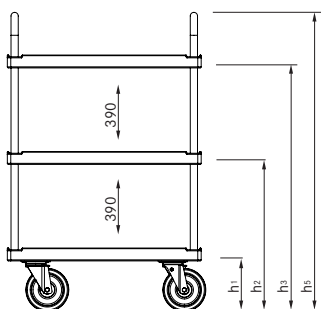
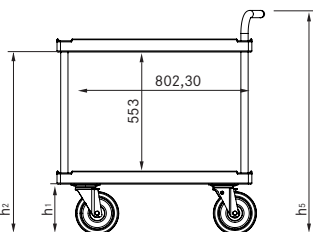
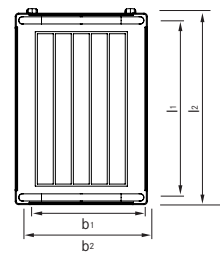



Rack trolley, high



Rack trolley, low



Table trolley



Pallet trolley with push bar



Pallet trolley with corner guards

## **Plastic trolleys.**

The innovative plastic trolleys from STILL make your logistics processes even more ergonomic and efficient. Light weight, flexible use, tray areas at comfortable heights and smooth rolling characteristics make the trolleys indispensable assistants.

## **Versatile.**

- The well designed modular concept suits a broad range of applications. The range of trolleys including flat pallet trolleys, trolleys with push bars, table trolley or rack trolleys allows handling many different tasks in production, warehouse or workshop. The STILL plastic trolleys are a perfect match with the STILL tugger train.

## **Easy handling.**

- These lightweight trolleys with smooth running polyamide wheels make any load handling easy and comfortable. The optional push bar supports an ergonomic body posture of the operator when pushing or pulling a load. Storage trays at a comfortable working height avoid strain of the back and provide large transport capacities.

## **Sturdy workmanship.**

- The impact and weather resistant plastic floors are easy to keep clean and make the STILL plastic trolley a resilient all-rounder for indoor and outdoor use. The combination of a corrosion free aluminium frame and the foam filled plastic floor of the trolley allow to carry heavy loads providing a load capacity of up to 1000 kgs with the basic element of this modular system.

## **Load securing.**

- Each plastic trolley is fitted with an edge to secure the load. In addition, optional load guards prevent parts of the load from dropping. For the pallet trolley four corner guards are available to hold the load in place. Two diagonally located parking brakes prevent the trolley from rolling off unintended.

## **Options:**

- Polyamide wheels with Polyurethane face for smooth and silent rolling.
- 1 ESD wheel (anti-static).
- Ball bearings, double.
- Push bar.
- Corner guards for pallet trolleys.
- Load guard for push bar trolley, table trolley and rack trolley.
- Load rest wall for table trolley and rack trolley.



## Your contact

STILL GmbH  
Berzeliusstraße 10  
D-22113 Hamburg  
Telephone: +49 (0)40/73 39-2000  
Telefax: +49 (0)40/73 39-2001  
info@still.de

**For further information please visit:**  
[www.still.de](http://www.still.de)

STILL Materials Handling Ltd.  
Aston Way, Leyland  
Lancashire PR26 7UX  
Telephone: +44 (0)1772 644300  
Telefax: +44 (0)1772 644303  
info@still.co.uk

**For further information please visit:**  
[www.still.co.uk](http://www.still.co.uk)

