



---

RX 50-10 C

---

RX 50-10

---

RX 50-13

---

RX 50-15

---

RX 50-16

---

## RX 50 Technical Data.

Electric Forklift Truck



In accordance with VDI guidelines 2198, this specification applies to the standard model only.  
Alternative tyres, mast types, ancillary equipment, etc. could result in different values.

Characteristics	1.1	Manufacturer			STILL	STILL	STILL	STILL	STILL
	1.2	Manufacturer's model designation			RX 50-10 C	RX 50-10	RX 50-13	RX 50-15	RX 50-16
	1.3	Drive: electric diesel, petrol, LPG			Electric	Electric	Electric	Electric	Electric
	1.4	Control - hand, pedestrian, stand-on, rider seated			Driver seat	Driver seat	Driver seat	Driver seat	Driver seat
	1.5	Carrying capacity/load	Q	kg	1000	1000	1250	1500	1600
	1.6	Load centre	c	mm	500	500	500	500	500
	1.8	Load distance	x	mm	330	330	330	330	335
	1.9	Wheel base	y	mm	974	1028	1136	1190	1190
	Weights	2.1	Weight		kg	2358	2372	2561	2826
2.2		Axle load with load front		kg	2833	2832	3247	3679	3866
2.2.1		Axle load with load rear		kg	525	540	564	647	567
2.3		Axle load without load front		kg	981	1024	1084	1133	1143
2.3.1		Axle load without load rear		kg	1377	1347	1477	1693	1690
Wheels/tyres	3.1	Tyres: Superelastic (SE), solid rubber (V)			SE	SE	SE	SE	SE
	3.2	Tyre size front			180/70-8	180/70-8	180/70-8	180/70-8	180/70-8
	3.3	Tyre size rear			180/70-8	180/70-8	180/70-8	180/70-8	180/70-8
	3.5	Wheels, no. front, (x = driven )			2	2	2	2	2
	3.5.1	Wheels no. rear (x = driven )			1x	1x	1x	1x	1x
	3.6	Track width front	b <sub>10</sub>	mm	840	840	840	840	840
	3.7	Track width rear	b <sub>11</sub>	mm					
Dimensions	4.1	Tilt angle, mast/fork carriage forwards		°	3	3	3	3	3
	4.1.1	Tilt angle, mast/fork carriage backwards		°	5	5	5	5	5
	4.2	Closed mast height	h <sub>1</sub>	mm	2160	2160	2160	2160	2160
	4.3	Free lift	h <sub>2</sub>	mm	150	150	150	150	150
	4.4	Lift height	h <sub>3</sub>	mm	3230	3230	3230	3230	3230
	4.5	Extended mast height	h <sub>4</sub>	mm	3805	3805	3805	3805	3805
	4.7	Height to top of overhead guard (cabin)	h <sub>6</sub>	mm	1980	1980	2050	2050	2050
	4.8	Seat height/stand height	h <sub>7</sub>	mm	953	953	953	953	953
	4.12	Height of coupling	h <sub>10</sub>	mm	-	-	-	-	-
	4.19	Overall length	l <sub>1</sub>	mm	2359	2413	2521	2575	2580
	4.20	Length incl. fork back	l <sub>2</sub>	mm	1559	1613	1721	1775	1780
	4.21	Overall width	b <sub>1</sub>	mm	990	990	990	990	990
	4.22	Fork thickness	s	mm	35	35	35	35	40
	4.22.1	Fork width	e	mm	80	80	80	80	80
	4.22.2	Fork length	l	mm	800	800	800	800	800
	4.23	Fork carriage DIN 15173, Class/form A, B			ISO II A	ISO II A	ISO II A	ISO II A	ISO II A
	4.24	Width of fork carriage	b <sub>3</sub>	mm	980	980	980	980	980
	4.31	Floor clearance beneath mast with load	m <sub>1</sub>	mm	90	90	90	90	90
	4.32	Floor clearance at centre wheel base	m <sub>2</sub>	mm	90	90	90	90	90
	4.33	Width of working aisle with 1000x1200 pallet wide	A <sub>st</sub>	mm	2888	2942	3050	3104	3109
4.34	Width of working aisle with 800x1200 pallet long	A <sub>st</sub>	mm	3010	3064	3172	3226	3231	
4.35	Turning radius	W <sub>a</sub>	mm	1229	1283	1391	1445	1445	
4.36	Shortest pivot point distance	b <sub>13</sub>	mm						
Performance	5.1	Driving speed with load		km/h	12,0	12,0	12,0	12,0	12,0
	5.1.1	Driving speed without load		km/h	12,5	12,5	12,5	12,5	12,5
	5.2	Lift speed with load		m/s	0,38	0,38	0,33	0,32	0,30
	5.2.1	Lift speed without load		m/s	0,54	0,54	0,54	0,54	0,54
	5.3	Lowering speed with load		m/s	0,54	0,54	0,54	0,54	0,54
	5.3.1	Lowering speed without load		m/s	0,60	0,60	0,60	0,60	0,60
	5.5	Towing capacity with load		N	1650	1650	1400	1280	1240
	5.5.1	Towing capacity without load		N	1950	1950	1700	1670	1670
	5.6	Max. towing capacity with load		N	2840	2840	3500	3770	3470
	5.6.1	Max. towing capacity without load		N	7150	7150	7150	7150	7150
	5.7	Climbing capacity with load		%	6,5	6,5	5,0	4,0	4,0
	5.7.1	Climbing capacity without load		%	11,0	11,0	8,5	8,0	7,5
	5.8	Max. climbing capacity with load		%	19,0	19,0	19,0	16,0	15,0
	5.8.1	Max. climbing capacity without load		%	25,0	25,0	25,0	25,0	25,0
5.9	Acceleration time with load		s	5,1	5,1	5,3	5,5	5,6	
5.9.1	Acceleration time without load		s	4,7	4,7	4,8	4,9	5,0	
5.10	Operating brake			hydraulic	hydraulic	hydraulic	hydraulic	hydraulic	
Motor	6.1	Performance drive motor S2-60 min		kW	4,9	4,9	4,9	4,9	4,9
	6.2	Performance lift motor at S3-15%		kW	7,6	7,6	7,6	7,6	7,6
	6.3	Battery acc. to DIN 43531/35/36 A,B, C, no			DIN 43535 A	DIN 43535 A	DIN 43535 A	DIN 43535 A	DIN 43535 A
	6.4	Battery voltage	U	V	24	24	24	24	24
	6.4.1	Battery capacity	K <sub>5</sub>	Ah	460	575	805	920	920
	6.5	Battery weight		kg	372	445	600	676	676
6.6	Energy consumption 60 VDI work cycles/hour		kWh/h	3,7	3,7	4,2	4,8	4,9	
Other	8.1	Type of drive control			-	-	-	-	-
	8.2	Operating pressure for attachment		bar	230	230	230	230	230
	8.3	Oil flow for attachment		l/min	30	30	30	30	30
	8.4	Noise level, driver's ear		dB(A)	63,9	63,9	63,9	63,9	63,9
	8.5	Trailer coupling, type DIN			-	-	-	-	-

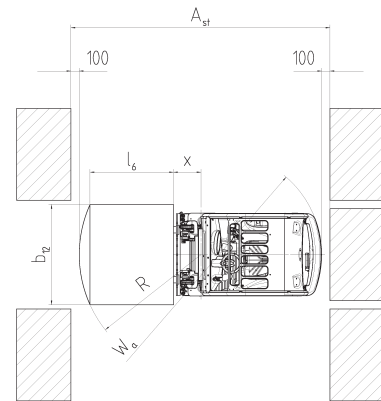
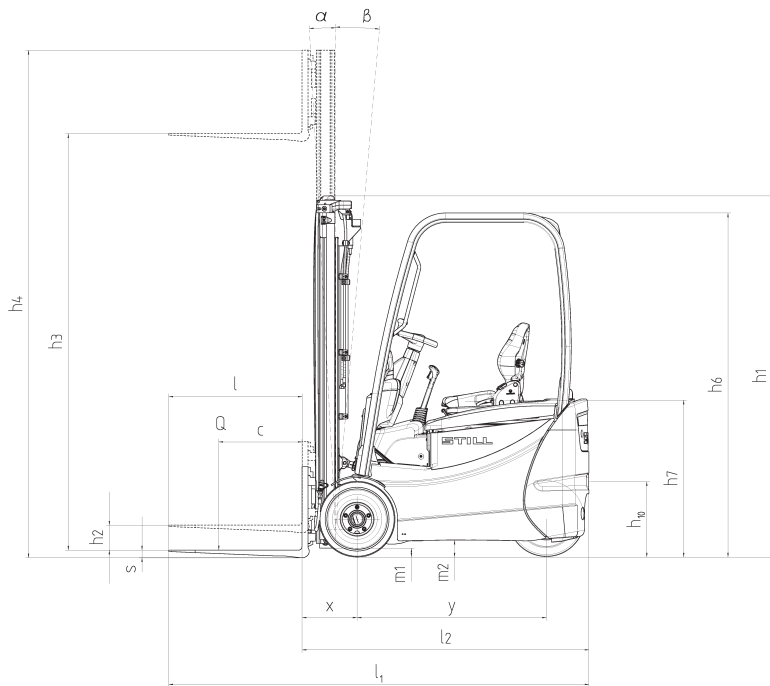

Dimensions indicate mast in vertical position

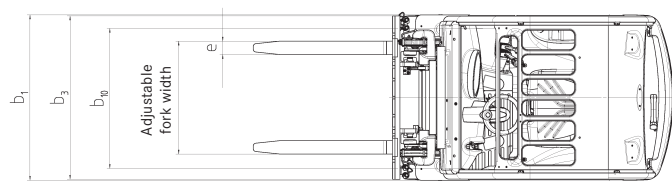

### Gradients

Maximum travel distance per hour.

Without load

	RX 50-10 C	RX 50-10	RX 50-13	RX 50-15	RX 50-16
25 %	1627 m	1628 m	1216 m	940 m	940 m
20 %	3275 m	3232 m	2401 m	1755 m	1755 m
15 %	4515 m	4492 m	4300 m	3997 m	3997 m
10 %	5775 m	5805 m	5479 m	5094 m	5068 m
5 %	8505 m	8641 m	8308 m	7468 m	7469 m

Variable speed

With load

	RX 50-10 C	RX 50-10	RX 50-13	RX 50-15	RX 50-16
19 %	1154 m	1094 m	667 m	-	-
15 %	2153 m	2153 m	1404 m	959 m	903 m
10 %	4504 m	4505 m	4108 m	3129 m	2679 m
5 %	6771 m	6770 m	6054 m	5479 m	5492 m

		Telescopic mast		HiLo mast		Triplex mast		
RX 50-10 C/10/13/15	Lift height	h <sub>3</sub>	mm	2830-5430	2975-3975	4320-6070		
	Closed height	h <sub>1</sub>	mm	1960-3260	1960-2460	1960-2610		
	Free lift form A	h <sub>2</sub>	mm	150	1405-1905	1405-2055		
	Overall raised height form A	h <sub>4</sub>	mm	3405-6005	3550-4550	4895-6645		
	Fork position centre - centre		mm	216 / 368 / 445 / 521 / 673 / 760				
	Overall length	L <sub>2</sub>	mm	See standard truck			Standard truck + 20mm	
	Load distance	x	mm	330			350	
	Load face	A <sub>st</sub>	mm	See standard truck			Standard truck + 20mm	
RX 50-16	Lift height	h <sub>3</sub>	mm	2830-5430	2975-3975	4320-6070		
	Closed height	h <sub>1</sub>	mm	1960-3260	1960-2460	1960-2610		
	Free lift form A	h <sub>2</sub>	mm	150	1362-1862	1362-2012		
	Overall raised height form A	h <sub>4</sub>	mm	3473-6073	3593-4593	4938-6688		
	Fork position centre - centre		mm	216 / 368 / 445 / 521 / 673 / 760				
	Overall length	L <sub>2</sub>	mm	See standard truck			Standard truck + 20mm	
	Load distance	x	mm	335			355	
	Load face	A <sub>st</sub>	mm	See standard truck			Standard truck + 20mm	

Truck widths RX 50-10C/10/13/15/16

Tyres		Track width front b10	Truck width b1
SE 180/70-8	mm	840	990
SE 180/70-8	mm	872	1028
SE 200/50-10	mm	930	1137
Solid rubber 18 x 7 x 12 1/8	mm	892	1078
Solid rubber 18 x 7 x 12 1/8	mm	1004	1192

For capacities, please refer to the respective diagrams

Basic capacities RX 50-10 and RX 50-10 C Tele/HiLo mast, SE and solid rubber tyres

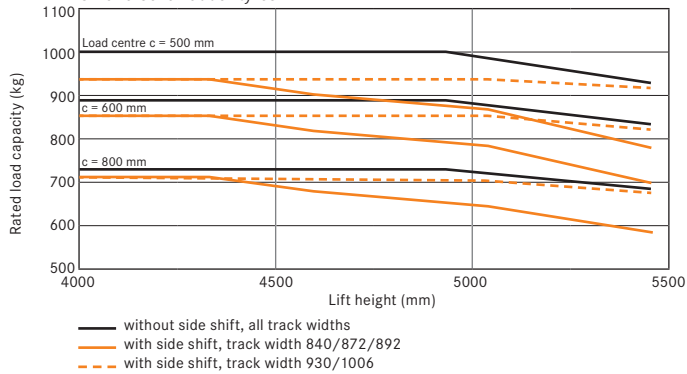

Basic capacities RX 50-13 Tele/HiLo mast, SE tyres

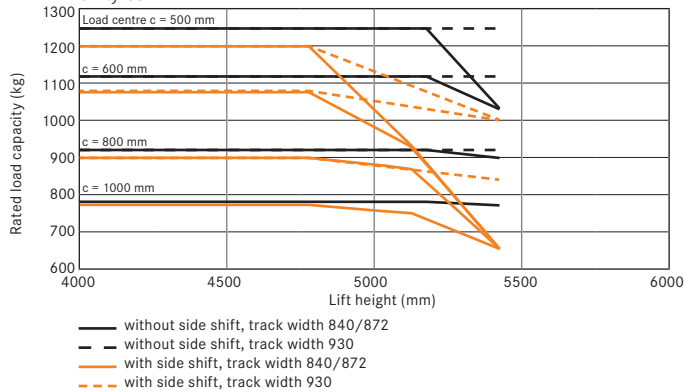

Basic capacities RX 50-10 triplex mast, SE and solid rubber tyres

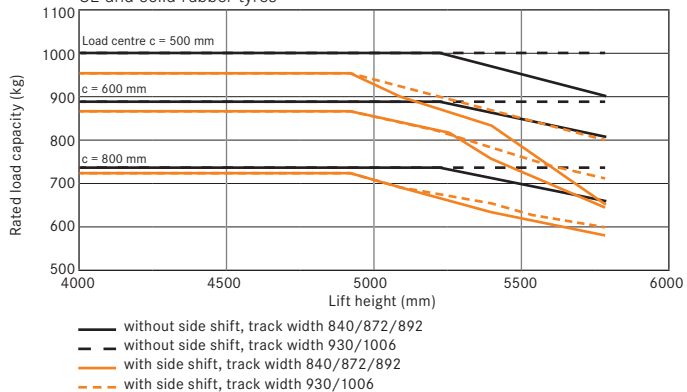

Basic capacities RX 50-13 Tele/HiLo mast solid rubber tyres

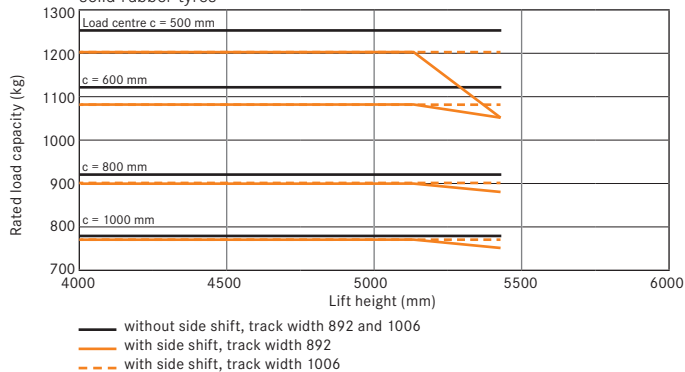

Basic capacities RX 50-10 C triplex mast, SE and solid rubber tyres

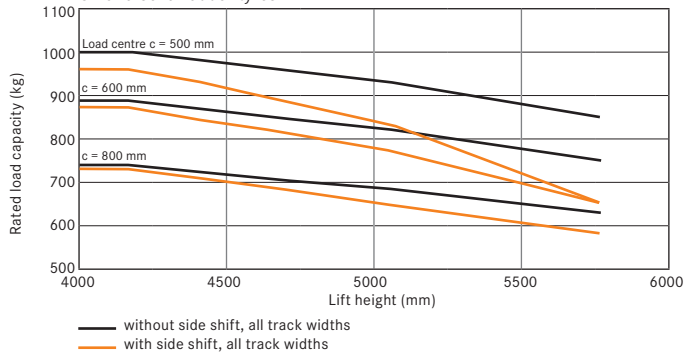

Basic capacities RX 50-13 triplex mast, SE tyres

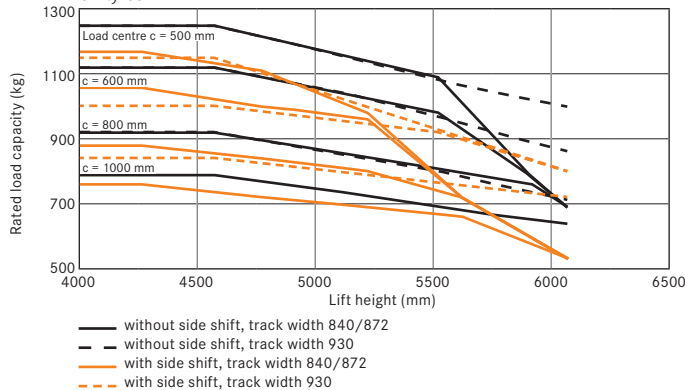

Basic capacities RX 50-13 triplex mast, solid rubber tyres

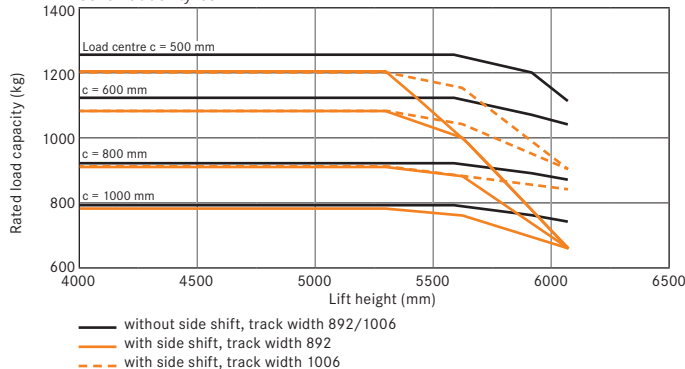

The indicated values may differ depending on the installed equipment.

Basic capacities RX 50-15 tele/HiLo mast, SE tyres

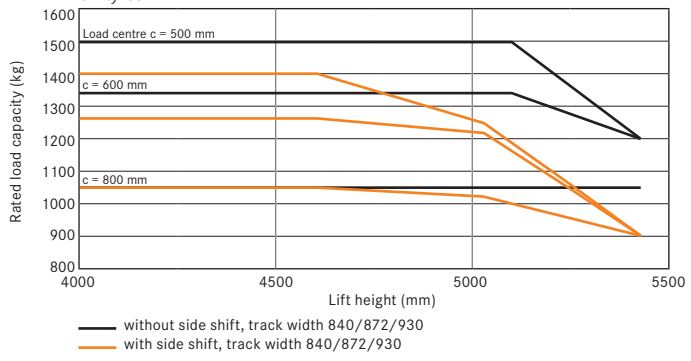

Basic capacities RX 50-16 tele/HiLo mast, SE tyres

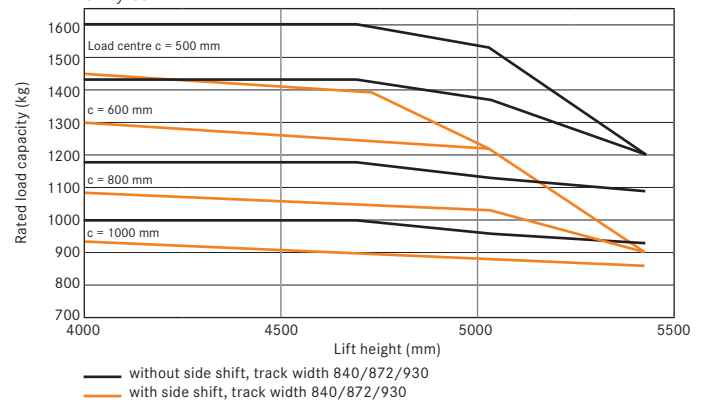

Basic capacities RX 50-15 tele/HiLo mast, solid rubber tyres

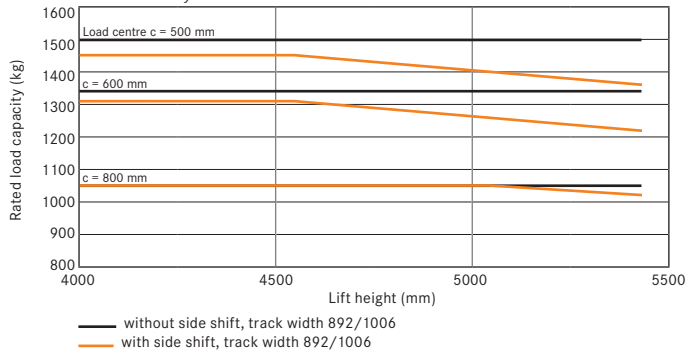

Basic capacities RX 50-16 tele/HiLo mast, solid rubber tyres

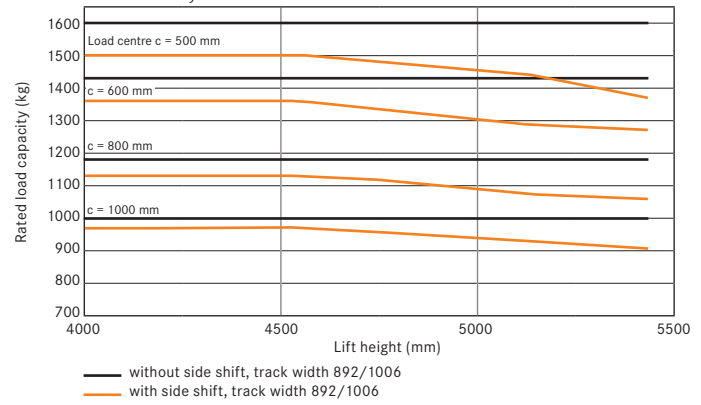

Basic capacities RX 50-15 triplex mast, SE tyres

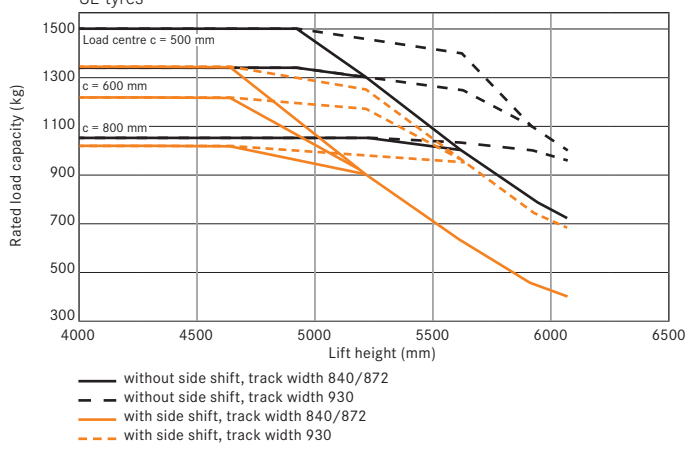

Basic capacities RX 50-16 triplex mast, SE tyres

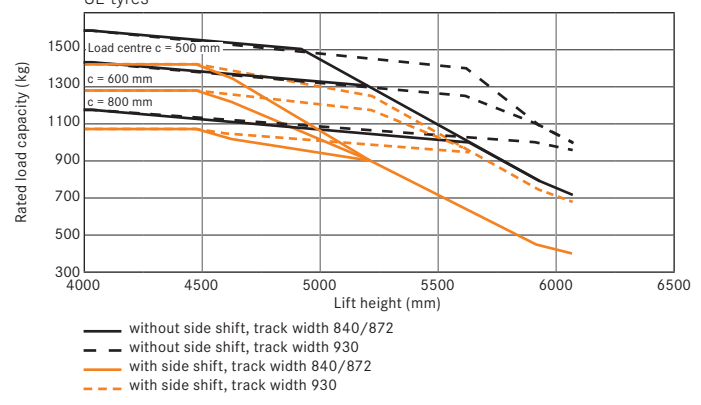

Basic capacities RX 50-15 triplex mast, solid rubber tyres

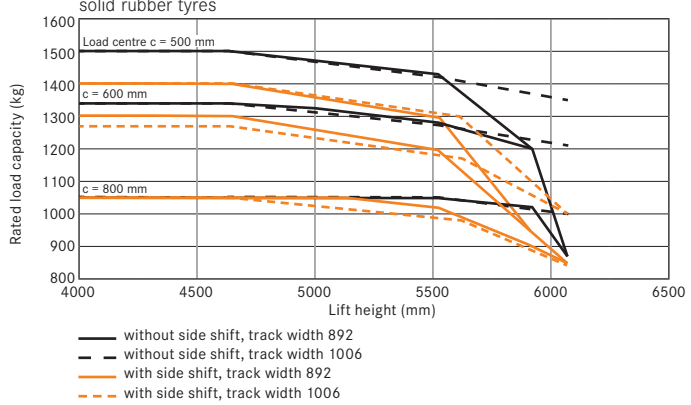

Basic capacities RX 50-16 triplex mast, solid rubber tyres

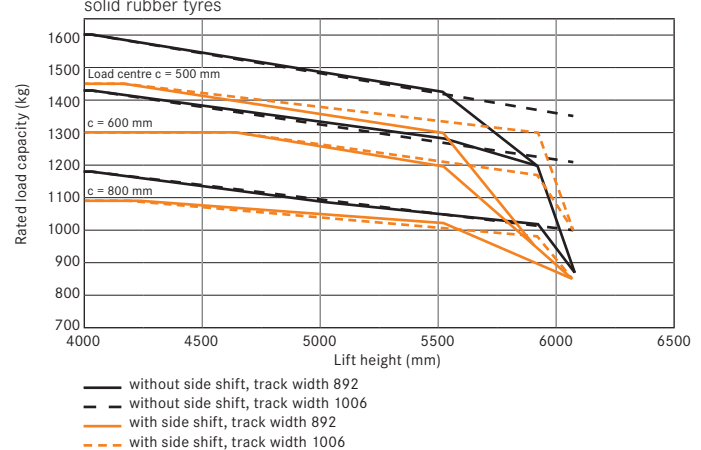

### Overall concept:

The RX 50 is the most compact electric three-wheel, rear wheel driven fork lift truck of its class. It is seamlessly integrated into the family of the STILL electric forklift trucks. The RX 50 is especially suitable to load and unload lorries, containers, train carriages and to move pallets inside the warehouse (Figure 1).

### Drive.

- 24 volt 3-phase drive motor acts directly on the steered rear wheel for high performance and driving dynamics.
- Capsulated AC drive and pump motor.
- Electrical wear free braking.

### Ergonomics.

- Large driver's compartment.
- High operational comfort for the driver due to optimum layout of all controls.
- Excellent vision to all sides.

### Safety.

- Optimum stability due to low centre of gravity.
- High residual capacity also at high lift heights.
- Excellent driving stability by optimised Curve Speed Control.

### Environment.

- Outstandingly low energy consumption for all work cycles.

### Service.

- Shortest maintenance interval 1000 hours or 12 months.
- Quick diagnosis via a laptop computer.
- Optimum maintenance access.
- Control unit protected by the counterweight.

### Technical features:

#### Driver's compartment.

- Low access height.
- Long grab handle on the overhead guard for different reach heights.
- Large footwell and inclined floor plate with anti-slip covering.
- Automotive style layout of foot pedals.
- Slim steering column without obstructing displays.
- Heated, fully graphical display with background lighting.
- Display and control unit directly in the field of vision of the driver (Figure 2).

#### Adaptable drive control.

- Acceleration and braking of the truck are operated by the drive pedal alone.
- Five selectable driving programmes allow the driver to adapt the driving characteristics at all times.
- Individual settings for speed, acceleration and braking within each driving programme.

### Blue-Q energy program.

- Activate the Blue-Q efficiency mode of the truck at the push a button.
- Energy saving due to intelligent optimisation of the drive characteristics without impairing the work process.
- Intelligently switches off electrical consumers.
- A saving in energy consumption of up to 12% depending on the application and the truck's equipment.

### Electrical system.

- Modern CAN-bus technology.
- 24 Volt electric equipment.
- Electrical system operates digitally.
- Two independent CAN-bus systems allow independent operation of the drive system and other functions of the truck.
- Tough control with two processors monitoring each other.
- Corrugated pipes and watertight plug connectors protect electrical connections.
- Pre-installed terminals allow easy, modular retrofitting of additional electrical equipment.

### Mast and hydraulics.

- Free view fork carriage with open frame profile.
- Wide, open telescopic mast with or without full free lift, also available as triplex version.
- Auto-adapting valve and steering control with dynamic power supply to match the speed of the pump motor with the demand.
- Sensitive hydraulics control with multi-levers for exact positioning.
- Low noise hydraulic pump.

### Additional equipment (options)

#### Truck equipment.

- Superelastic or solid rubber tyres.
- Closed height less than 2 m to pass doorways.

#### Battery change from the side.

- Simplified decentralised charging of exchange batteries for multi-shift operation.
- Fast and efficient battery change.
- Minimized risk of damaging the battery or the truck.
- Higher safety.
- No battery lifting gap in the overhead guard improves upward vision and enables a better fit for the roof screen thus reducing vibration noises (Figure 3 and 4).

### Cabin equipment.

- Modular cabin design with front and roof screen.
- Canvas cabin with large window, side and rear covers.
- Large windscreen wipers for front screen, standard with washer system.
- Unbreakable interior and exterior mirrors.
- Comfort seats with cloth covering, air suspension, seat heating, lumbar support and high backrest.
- Easybelt seat belt system.
- Retaining bar on the seat.
- Retaining bar doors.
- Load rest.
- Protective roof grid.
- Sun visor.
- Writing pad, document pocket.
- Cold store version.

### Controls.

- Two pedal drive control.
- Operation of hydraulic functions by joystick, Fingertipp controls or mini-levers.

### Electrical equipment and truck control.

- Driver assistance systems for additional safety e. g. safety belt monitor or reduced driving speed while the fork is raised.
- General speed limit.
- Automotive style lighting system, appropriate for road traffic use.
- Spotlights front and/or rear, for front also available as twin spotlights.
- Warning lights.
- Preparation for material flow management systems (MMS).
- FleetManager allows to assign access permissions, analysis of operating data and accident recorder.
- Data communication also wireless.

### Mast and hydraulics.

- Auxiliary hydraulics to control functions of attachments.
- Different widths of fork carriages and different fork lengths.
- Attachments to suit the loaded goods.
- Oil accumulator dampens transition jerks in the hydraulic system.



1) RX 50-10 C



2) Driver's compartment



3) Battery change with a standard hand pallet truck, low lift truck or battery change frame



4) On-board roller platform for exchange by hoist



## Your contact

STILL GmbH

Berzeliusstraße 10

D-22113 Hamburg

Telephone: +49 (0)40/73 39-2000

Telefax: +49 (0)40/73 39-2001

[info@still.de](mailto:info@still.de)

**For further information please visit:**

**[www.still.de](http://www.still.de)**

STILL Materials Handling Ltd.

Aston Way, Leyland

Lancashire PR26 7UX

Telephone: +44 (0)1772 644300

Telefax: +44 (0)1772 644303

[info@still.co.uk](mailto:info@still.co.uk)

**For further information please visit:**

**[www.still.co.uk](http://www.still.co.uk)**