

NEW



## HYDRAULIC EXCAVATOR | JS330/360 LC/NLC

Net engine power: 210kW (281hp) Operating weight: 32029kg/38016kg



# PERFORMANCE AND PRODUCTIVITY.

BEFORE YOU BUY AN EXCAVATOR, YOU NEED TO KNOW IT'S GOING TO BE TOUGH ENOUGH TO PERFORM ANY JOB YOU ASK OF IT. FORTUNATELY, WITH A JCB JS330/360, STRENGTH AND DURABILITY COME AS STANDARD.



The new DIESELMAX 672 engine is based on our proven 4.8 litre unit; to further guarantee durability, there's a heavy-duty cast iron block, bedplate, cylinder head and forged crankshaft.

## Boom and dipper.

1 A JCB JS330/360's reinforced boom and dipper is made of high tensile strength steel, with internal baffle plates for long life durability. In addition we fit heavy-duty wear strips at the dipper end for increased durability.

2 Our advanced manufacturing and assembly processes produce high precision and quality assembled components.

We use Finite Element Analysis with extensive rig and endurance testing to make key components last longer.



1

## Componentry.

3 JCB JS330/360s boast the best components in the industry, including new JCB DIESELMAX 672 engine, Berco running gear, Kawasaki pumps and Kayaba main control valves.

JCB DIESELMAX 672 is equipped with high capacity multi-stage fuel filtration. This consists of water separation and first stage 10 micron filtration followed by 2 micron fine filtration and finally an ultra-fine 2 micron filter. This system protects against a wide range of types of contaminants in fuel.



3



3



2



### Structural strength.

- 4 The high-strength undercarriage of a JCB JS330/360 uses a fully-welded X frame construction for long-term durability even in the most demanding applications.
- 5 A closed box section revolving frame increases strength and reduces stress. It is also highly resistant to impact damage.
- 6 The JS330/360's high-strength rigid upper frame provides maximum durability and support.
- 7 Our stiff, durable door design gives great strength and rigidity.

**UNEARTHED: KEY FACT**  
The JCB JS330/360 turret is welded to both the upper and lower undercarriage frame.

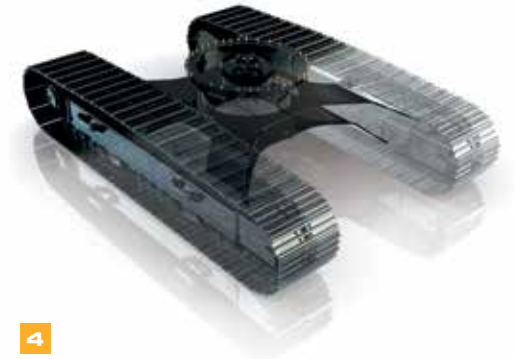

4



5



7



6

# MAXIMUM PRODUCTIVITY, MINIMUM SPEND.

IT'S MORE IMPORTANT THAN EVER TO SAVE MONEY AND TIME; THE JCB JS330/360 RANGE IS DESIGNED TO MAKE THE MOST OF BOTH.



3

## Upping output.

1 With up to a massive 272kN of bucket tearout and fast cycle times, the JS330/360 is extremely productive in all applications

2 Simultaneous tracking and excavating is smooth and fast with an intuitive multifunction operation.

## Efficiency.

Advanced hydraulic technology ensures that the machines always starts in idle for maximum fuel efficiency, contributing to fuel savings.

Optimised hydraulic pump settings and a revised spool configuration within the main valve block, only delivers the required oil flow, preventing wasted energy.

1



2

The JS330/360's have variable power bands that allow you to tailor performance – and therefore economy – to specific tasks.

3 The new SMART Control electronics and Tier 2 JCB DIESELMAX engines benefit by working together to deliver a smooth high torque power band even at low engine speed up to the max of 210kW/281hp.

Boasting JCB's latest EcoMAX combustion technology, a state-of-the-art engine control system, a variable speed fan and uprated cooling apparatus, the DIESELMAX 672 uses 25% less fuel than its predecessor.



3



**UNEARTHED: KEY FACT**  
 To save fuel, JCB Auto-Idle technology automatically reduces engine speed when hydraulics aren't in use.

**Stability, hydraulics and attachments.**

**4** JCB's innovative hydraulic regeneration system means oil is recycled across the cylinders for faster cycle times and reduced fuel consumption.

**5** A JCB JS330/360 has cushioned boom and dipper ends to prevent shock loadings, protect your machine and increase operator comfort.

**6** A JCB JS330/360 has a solid, stable work platform for fast cycle times.

For ultra versatility, JCB offers a full list of auxiliary pipework options including hammer, auxiliary, merged and low flow.



## A COMFORTABLE FAVOURITE.

JCB EXCAVATORS ARE DESIGNED AROUND THE OPERATOR. THAT'S GOOD FOR THEM BUT EVEN BETTER FOR YOU; AFTER ALL, GREAT COMFORT AND EASE OF USE EQUALS GREAT PRODUCTIVITY.

### Visibly better.

**1** A 70/30 front screen split gives JCB JS330/360s excellent front visibility. A clear view of the front right track provides easy, safe trench digging and manoeuvring.

**2** An innovative low-level bonnet provides excellent rearward visibility.

### Comfortably in control.

**3** The 3.5" colour multi-function display is easy to read in all light conditions, provides instant operational information, and has a customisable home screen.

The JS330/360's optional Tool Select feature can set up auxiliary hydraulic circuits quickly and accurately to match flow and pressure requirements of any attachment.



A large laminated glass roof window gives the JS330/360 optimum visibility for working at height.

Light, intuitive and smooth controls improve comfort and productivity. The JS330/360's joystick-mounted power boost button gives extra hydraulic power fast.

A balanced slew and electronic/hydraulic controlled slew braking give speed and precision.





5

### The working environment.

**4** The JS330/360 creates a quieter working environment inside and out. Because we've reduced noise levels to 70dB(A) inside and 101dB(A) outside, you can use the machine at any location, any time.

JCB JS330/360 cabs use 6 viscous rubber mounts to minimise noise and vibration.

The positive pressure cab keeps out dirt and dust.

**5** JCB's climate control option offers a precisely controlled cab temperature with fresh or recirculated air. Demisting/defrosting functions keep a JS330/360's front window clear.

**6** There's a spacious luggage tray behind the operator's seat.

**7** A large floor area with large high grip pedals gives easy and precise tracking.



6



7



The JS330/360's cab and controls are independently adjustable so that it's easy to find the perfect operating position.

We offer tailored seating options to suit many different applications.

4

# LESS SERVICING, MORE SERVICE.

WE'VE DESIGNED JCB JS330/360 TO BE LOW MAINTENANCE AND EASILY SERVICEABLE. WHICH MAKES THEM AFFORDABLE, EFFICIENT AND HIGHLY PRODUCTIVE. HELPING YOU GET THE BEST SERVICE FROM YOUR MACHINE.



By using graphite impregnated bronze bushes, we've reduced the JS330/360's boom and dipper greasing intervals to 1000 hours for normal applications.



### Easy does it.

- 1 The air filter on a JS330/360 is easily accessible, and a double-element construction simplifies cleaning.
- 2 The filters on a JCB JS330/360 (engine oil, hydraulic oil and fuel) are centrally located for fast, easy servicing.

	SERVICE INTERVALS
Engine oil and oil filter	Every <b>500</b> hours
Hydraulic oil	Every <b>5000</b> hours
Hydraulic oil filter	Every <b>1000</b> hours

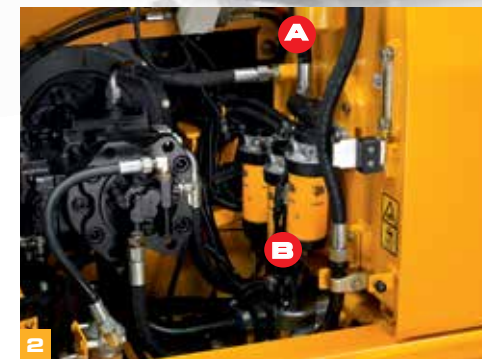

(A) Hydraulics oil filters (B) Fuel filters





**UNEARTHED: KEY FACT**  
 JCB JS330/360 grease points are centralised for safe and easy access to high level pivots.

JCB JS330/360 bonnets open and close easily with gas-assisted cylinders, and the service bays are large and wide for good access.

**Here to help.**

- 3 JCB's Smart Control automatically checks the engine oil and engine coolant level on machine start up.
- 4 Because they're mounted side by side on a JCB JS330/360, the engine radiator, hydraulic cooler and intercooler can be serviced individually yet cleaned easily.
- 5 Service your JCB JS330/360 with your local main dealer and our trained engineers can minimise downtime. Order genuine JCB parts online and, in 95% of cases, they'll be with you next day. For extra security and machine protection, opt for a package like JCB LiveLink remote machine monitoring.



# THE SAFE CHOICE.

ON-SITE SAFETY IS CRUCIAL, SO WE'VE DESIGNED THE JS330/360 TO INCORPORATE AS MANY CUTTING EDGE SAFEGUARDS AS POSSIBLE. IN SHORT, YOUR OPERATORS ARE IN SAFE HANDS.



**1** JCB JS330/360 bonnet opens front-to-rear for easy and safe engine service access.



**2** For extra peace of mind, JCB JS330/360 cabs are available with an optional external ROPS and FOPS protection.

**3** JCB's Safety Level Lock fully isolates hydraulic functions to avoid unintended movements. Our 2GO system means a JCB JS330/360 can only be started in a safe locked position via two separate inputs.

**4** JCB JS330/360s have a large glass area and low bonnet line for superb visibility.

**5** A JCB JS330/360's steps and platforms have anti-slip punched steel plates for optimum grip, even in wet or icy conditions. Bolt-on plates have recessed bolts to reduce trip hazard.

**6** JCB's optional rear-view and side-view cameras display uninterrupted rearward and sideward views on the smart controller display.

**7** Equip your JCB JS330/360 with a full set of side and rear view mirrors for all round visibility and safety compliance.



We've fitted as standard a bulk head heat shield between the pumps and the engine to guard against heat and noise.

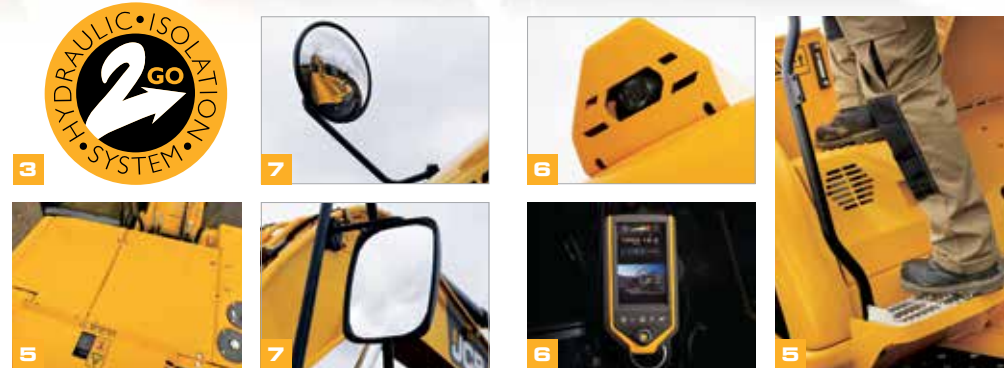

**3**

**7**

**6**

**5**

**5**

**7**

**6**

**5**

## LIVELINK, WORK SMARTER.

**JCB LIVELINK IS AN INNOVATIVE SOFTWARE SYSTEM THAT LETS YOU MONITOR AND MANAGE YOUR MACHINES REMOTELY – ONLINE, BY EMAIL OR BY MOBILE PHONE.**

**Productivity and cost benefits –**

Machine location information can improve fleet efficiency and you may even enjoy reduced insurance costs courtesy of the added security that LiveLink brings.

*\* Note: Please consult your local dealer for LiveLink availability*

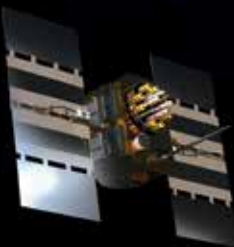

**Maintenance benefits** – Accurate hours monitoring, maintenance history records, critical machine alerts and service alerts improve maintenance planning.

**Security benefits** – Real-time geofencing lets you set operating zones and curfew alerts that tell you when your machinery operates outside of pre-determined times. Location information helps you store machines safely.

## VALUE ADDED.

**JCB'S WORLDWIDE CUSTOMER SUPPORT IS FIRST CLASS. WHATEVER YOU NEED AND WHEREVER YOU ARE, WE'LL BE AVAILABLE QUICKLY AND EFFICIENTLY TO HELP MAKE SURE YOUR MACHINERY IS PERFORMING TO ITS FULL POTENTIAL.**



1

1 Our Technical Support Service provides instant access to factory expertise, day or night, while our Finance and Insurance teams are always on hand to provide fast, flexible, competitive quotes.

JCB Assetcare offers comprehensive extended warranties and service agreements, as well as service-only or repair and maintenance contracts. Irrespective of what you opt for, our Maintenance teams around the world charge competitive labour rates, and offer non-obligation quotations as well as fast, efficient insurance repair work.



2

2 The global network of JCB Parts Centres is another model of efficiency; with 15 regional bases, we can deliver around 95% of all parts anywhere in the world within 24 hours. Our genuine JCB parts are designed to work in perfect harmony with your machine for optimum performance and productivity.

*Note: JCB LIVELINK and JCB ASSETCARE may not be available in your region, so please check with your local dealer.*

STATIC DIMENSIONS

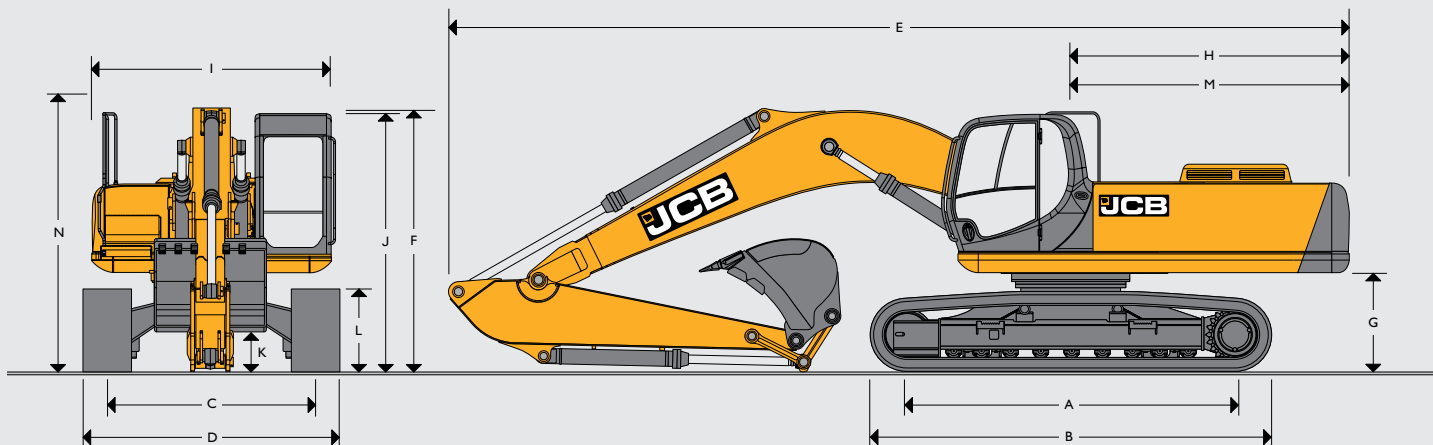

STATIC DIMENSIONS – JS330

Model		LC	NLC
A	Track length on ground	mm 3910	3910
B	Undercarriage overall length	mm 4810	4810
C	Track gauge	mm 2600	2390
D	Width over tracks (600mm trackshoes)	mm 3200	2990
D	Width over tracks (700mm trackshoes)	mm 3300	3090
D	Width over tracks (800mm trackshoes)	mm 3400	3190
D	Width over tracks (900mm trackshoes)	mm 3500	3290
G	Counterweight clearance	mm 1190	1190
H	Tail swing radius	mm 3413	3413
I	Overall width of superstructure	mm 2990	2990
J	Height over cab	mm 3170	3170
K	Ground clearance	mm 500	500
L	Track height	mm 1026	1026
M	Tail length	mm 3383	3383
N	Height over grab rail	mm 3196	3196

		Standard boom 6.45m			
Dipper lengths		2.21m	2.63m	3.23m	4.03m
E	Transport length	mm 11203	11113	11013	11103
F	Transport height	mm 3610	3570	3360	3850

		ME boom 6.10m	
Dipper lengths		2.21m	2.63m
E	Transport length	mm 10853	10763
F	Transport height	mm 3610	3570

STATIC DIMENSIONS – JS360

Model		LC	NLC
A	Track length on ground	mm 4021	4021
B	Undercarriage overall length	mm 4954	4954
C	Track gauge	mm 2600	2390
D	Width over tracks (600mm trackshoes)	mm 3200	2990
D	Width over tracks (700mm trackshoes)	mm 3300	3090
D	Width over tracks (800mm trackshoes)	mm 3400	3190
D	Width over tracks (900mm trackshoes)	mm 3500	3290
G	Counterweight clearance	mm 1214	1214
H	Tail swing radius	mm 3593	3593
I	Overall width of superstructure	mm 2990	2990
J	Height over cab	mm 3220	3220
K	Ground clearance	mm 530	530
L	Track height	mm 1024	1024
M	Tail length	mm 3564	3564
N	Height over grab rail	mm 3220	3220

		Standard boom 6.45m			
Dipper lengths		2.21m	2.63m	3.23m	4.03m
E	Transport length	mm 11413	11353	11253	11333
F	Transport height	mm 3440	3510	3280	3700

		ME boom 6.10m	
Dipper lengths		2.21m	2.63m
E	Transport length	mm 10853	10763
F	Transport height	mm 3500	3570

ENGINE	
Model	JCB DIESELMAX 672
Type	Water cooled, 4-stroke, 6-cylinder in-line, common rail direct injection, turbocharged and intercooled diesel.
Rated power	210kW (281hp) at 1900 rpm.
Piston Displacement	7.2 litres
Air Filtration	Dry element with secondary safety element and in-cab warning indicator.
Starting system	24 volt.
Batteries	2 x 12 volt.
Alternator	24 volt, 50 ampere.

SWING SYSTEM	
Swing motor	Axial piston type.
Swing brake	Hydraulic braking plus automatic spring applied disc type parking brake.
Final drive	Planetary reduction.
Swing speed	<b>JS330:</b> 8.7 rpm <b>JS360:</b> 9.1 rpm
Swing gear	Large diameter, internally toothed fully sealed grease bath lubricated.

UNDERCARRIAGE	
Carriage options	L - Long Carriage and NL - Narrow Long Carriage.
Construction	Fully welded, 'X' frame type with central bellyguarding and sloping sidemembers with dirt relief holes under top rollers.
Recovery point	Front and rear.
Track shoe options	600mm, 700mm, 800mm, 900mm.
Upper and lower rollers	Heat treated, sealed and lubricated.
Track adjustment	Grease cylinder type.
Track idler	Sealed and lubricated, with spring cushioned recoil.
Track type	Sealed and lubricated.
LC and NLC	
No. of track guides	2 per side
No. of lower rollers	9 per side
No. of upper rollers	2 per side
No. of track shoes	50 per side

TRACK DRIVE		
Type	Fully hydrostatic, three speed with autoshift.	
Travel motors	Variable swash axial piston type, fully guarded within undercarriage frame.	
Final drive	Planetary reduction, bolt-on sprockets.	
Service brake	Hydraulic counter balance valve to prevent overspeeding on gradients.	
Park brake	Disc type, spring applied, automatic hydraulic release.	
Gradeability	70% (35 deg) continuous.	
Travel speed	<b>JS330</b>	<b>JS360</b>
	High – 5.2 km/h	High – 5.4 km/h
	Mid – 3.5 km/h	Mid – 3.1 km/h
	Low – 2.4 km/h	Low – 2.2 km/h
Tractive effort	226kN	293kN

HYDRAULIC SYSTEM	
A variable flow load sensing system with flow on demand, variable power output and servo operated, multi-function open centre control.	
Pumps	
Main pumps	2 variable displacement axial piston type.
Maximum flow	<b>JS330:</b> 2 x 290 l/min <b>JS360:</b> 2 x 304 l/min
Servo pump	Gear type.
Maximum flow	30 L/min 15cc/rev
Control valve	

A combined four and five spool control valve with auxiliary service spool as standard. When required twin pump flow is combined to boom, dipper and bucket services for greater speed and efficiency.

Relief valve settings	
Boom/Arm/Bucket	319 bar
With power boost	348 bar
Swing circuit	284 bar
Travel circuit	343 bar
Pilot control	45 bar

Hydraulic cylinders	
Double acting type, with bolt-up end caps and hardened steel bearing bushes. End cushioning is fitted as standard on boom, dipper and bucket rams.	

Filtration	
The hydraulic components are protected by the highest standard of filtration to ensure long hydraulic fluid and component life.	
In tank	150 micron, suction strainer.
Main return line	10 micron, fibreglass element.
Plexus Bypass line	1.5 micron, paper element.
Pilot line	10 micron, paper element.
Hydraulic hammer return	10 micron, reinforced microform element.

Cooling	
Worldwide cooling is provided via a single faced full return line air blast cooler with anti-block wavy cooling fins.	

EXCAVATOR END – MONOBOOM	
Monoboom available along with a choice of dipper lengths to suit the requirements of reach, dig-depth, loadover height and tearouts. Reserve strength is built into the fully welded structures for hydraulic hammer and other arduous operations. Fabricated bucket tipping links are provided with a choice of lift points.	

EXCAVATOR END – ME	
6.1m monoboom combined with short dipper options gives optimised lift performance maximising bucket capacity. For bulk digging applications.	

EXCAVATOR END – T.A.B	
Triple articulated boom available along with a choice of dipper lengths to suit the requirements of reach, dig-depth, loadover height, tearouts and site versatility. Reserve strength is built into the fully welded structures for hydraulic hammer and other arduous operations. Fabricated bucket tipping links are provided with a choice of lift points. Strong, durable construction, large cross sections and multi plate fabrications to withstand high stress applications. The boom is designed to ensure the optimum digging envelope when matched with the three dipper lengths.	

## CONTROLS

Excavator	All servo lever operated to ISO control pattern, independently adjustable to the seat.
Tracks	Individually servo operated by foot pedal or hand lever. Speed selection via joystick button.
Auxiliary	Via servo operated foot pedal.
Control isolation	Via gate lock lever at cab entrance or panel switch.
Engine speed	Dial type throttle control plus servo lever mounted one-touch idle control or separate selectable auto-idle with adjustable time delay using AMS.
Engine stop	Ignition key operated and separate shut-down button.
Horn	Operated via servo lever mounted button.

## STANDARD EXCAVATING BUCKETS – JS330

Standard excavating buckets are fully welded, heavy duty steel with hardened and sealed pivot pins.

## Mono Boom length: 6.45m

Bucket width	mm	900	1000	1200	1350	1500	1600	1800
Bucket capacity	m <sup>3</sup>	0.85	0.98	1.245	1.45	1.49	1.61	1.845
Bucket weight	kg	921	974	1107	1228	1252	1304	1420

## Dipper length

2.21m	□	□	□	□	□	□	□	□
2.63m	□	□	□	□	□	□	□	●
3.23m	□	□	□	□	●	●	●	●
4.03m	□	□	□	●	●	■	■	■

## ME Boom length: 6.1m

Bucket width	mm	1800	1750	1750
Bucket capacity	m <sup>3</sup>	1.845	2.2	2.34
Bucket weight	kg	1420	1790	1850

## Dipper length

2.21m	□	●	●
2.63m	□	■	■

□ = Material weight up to 1800kg/m<sup>3</sup>.

● = Material weight up to 1500kg/m<sup>3</sup>.

■ = Material weight up to 1200kg/m<sup>3</sup>.

These recommendations are given as a guide based on typical operating conditions.

Please contact your distributor for the correct selection of buckets and attachments to suit the application.

## SERVICE CAPACITIES

Machine model		JS330	JS360
Fuel tank	Litres	590	590
Engine coolant	Litres	45	45
Engine oil	Litres	25	25
Swing reduction gear	Litres	14.5	14.5
Track reduction gear (each side)	Litres	5	5
Hydraulic system	Litres	430	430
Hydraulic tank	Litres	239	239

## STANDARD EXCAVATING BUCKETS – JS360

Standard excavating buckets are fully welded, heavy duty steel with hardened and sealed pivot pins.

## Mono Boom length: 6.45m

Bucket width	mm	900	1000	1200	1350	1500	1600	1800	1750	1750
Bucket capacity	m <sup>3</sup>	0.85	0.98	1.245	1.45	1.49	1.61	1.845	2.2	2.34
Bucket weight	kg	921	974	1107	1228	1252	1304	1420	1790	1850

## Dipper length

2.21m	□	□	□	□	□	□	□	□	●	●
2.63m	□	□	□	□	□	□	□	□	●	■
3.23m	□	□	□	□	□	□	□	●	■	■
4.03m	□	□	□	□	□	□	●	■	×	×

## ME Boom length: 6.1m

Bucket width	mm	1800	1750	1750
Bucket capacity	m <sup>3</sup>	1.845	2.2	2.34
Bucket weight	kg	1420	1790	1850

## Dipper length

2.21m	□	●	●
2.63m	□	■	■

□ = Material weight up to 1800kg/m<sup>3</sup>.

● = Material weight up to 1500kg/m<sup>3</sup>.

■ = Material weight up to 1200kg/m<sup>3</sup>.

× = Not recommended.

These recommendations are given as a guide based on typical operating conditions.

Please contact your distributor for the correct selection of buckets and attachments to suit the application.

## WEIGHTS AND GROUND BEARING PRESSURES – JS330

Figures include 1.8cu.m. bucket operator, full fuel tank and 3.23m dipper.

		600mm shoes	700mm shoes	800mm shoes	900mm shoes
<b>JS330 NLC Monoboom</b>					
Machine weight	kg	32029	32489	32889	33289
Ground bearing pressure	kg/cm <sup>2</sup>	0.64	0.56	0.49	0.44
<b>JS330 LC Monoboom</b>					
Machine weight	kg	32229	32629	33029	33429
Ground bearing pressure	kg/cm <sup>2</sup>	0.65	0.56	0.5	0.45

## WEIGHTS AND GROUND BEARING PRESSURES – JS360

Figures include 1.8cu.m. bucket operator, full fuel tank and 3.23m dipper.

		600mm shoes	700mm shoes	800mm shoes	900mm shoes
<b>JS360 NLC Monoboom</b>					
Machine weight	kg	36522	36967	37412	37857
Ground bearing pressure	kg/cm <sup>2</sup>	0.71	0.62	0.54	0.49
<b>JS360 LC Monoboom</b>					
Machine weight	kg	36681	37126	37571	38016
Ground bearing pressure	kg/cm <sup>2</sup>	0.71	0.62	0.55	0.49

**WORKING RANGE – JS330**







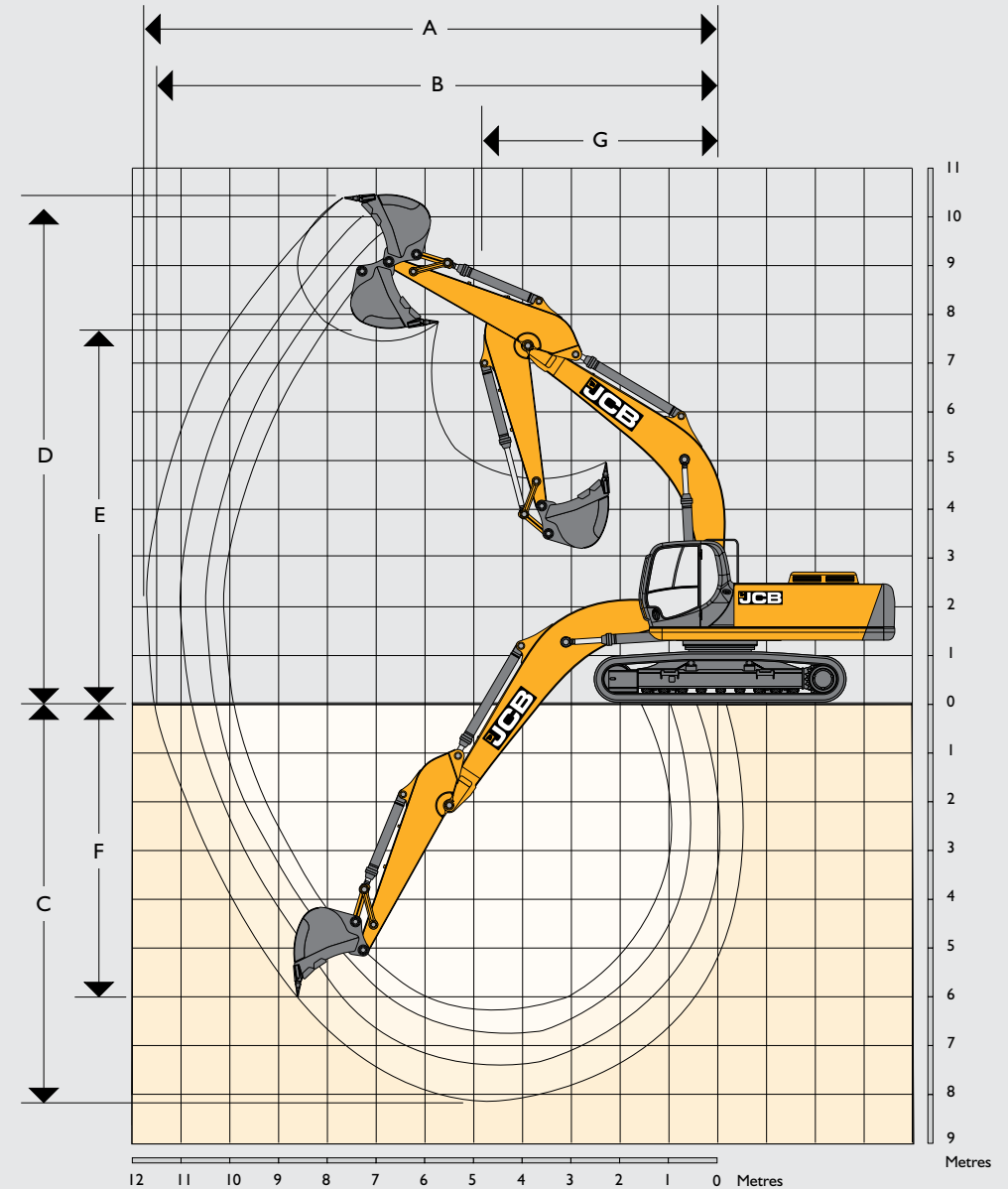







		JS330		JS360		
<b>Boom length: 6.45m</b>						
<b>Dipper length:</b>						
A	Maximum digging reach	mm	10170	10570	10060	10460
B	Maximum digging reach (on ground)	mm	9960	10370	9850	10255
C	Maximum digging depth	mm	6370	6800	6250	6680
D	Maximum digging height	mm	9740	9980	9510	9730
E	Maximum dumping height	mm	6710	6910	6800	7000
F	Maximum vertical wall cut depth	mm	5020	5610	2390	2910
G	Minimum swing radius	mm	4670	4640	4740	4710
	Bucket rotation	degrees	184.5	184.5	185	185
	Dipper tearout with boost	kgf	21346	18621	25300	22083
	Bucket tearout with boost	kgf	24144	24144	27716	27716

<b>Boom length: 6.45m</b>						
<b>Dipper length:</b>						
A	Maximum digging reach	mm	11130	11860	11020	11760
B	Maximum digging reach (on ground)	mm	10940	11680	10820	11570
C	Maximum digging depth	mm	7390	8190	7270	8070
D	Maximum digging height	mm	10280	10550	10020	10220
E	Maximum dumping height	mm	7190	7460	7260	7570
F	Maximum vertical wall cut depth	mm	6340	7120	3580	4390
G	Minimum swing radius	mm	4510	4520	4570	4620
	Bucket rotation	degrees	184.5	184.5	185	185
	Dipper tearout with boost	kgf	15451	13379	18319	15724
	Bucket tearout with boost	kgf	24144	24144	27716	27716















<b>ME Boom – Boom length: 6.10m</b>						
<b>Dipper length:</b>						
A	Maximum digging reach	mm	9782	10190	9782	10190
B	Maximum digging reach (on ground)	mm	9566	9984	9566	9984
C	Maximum digging depth	mm	5960	6387	5960	6387
D	Maximum digging height	mm	9450	9722	9450	9722
E	Maximum dumping height	mm	6662	6898	6662	6898
F	Maximum vertical wall cut depth	mm	3097	3690	3097	3690
G	Minimum swing radius	mm	4350	4347	4350	4347
	Bucket rotation	degrees	184.5	184.5	184.5	184.5
	Dipper tearout with boost	kgf	21346	18621	24940	21770
	Bucket tearout with boost	kgf	24144	24144	27716	27716

















**LIFT CAPACITIES – Dipper length: 2.21m, Boom: 6.45m, Trackshoes: 600mm triple grouser. JS330 LC MONO**

Load Point	Reach from Swing Centre														
	1.5m		3m		4.5m		6m		7.5m		9m		Max Reach		
															
Height	kg	kg	kg	kg	kg	kg	kg	kg	kg	kg	kg	kg	kg	kg	mm
7.5m							8640*	8640*					8580*	8100	6491
6m							8960*	8960*	8240*	6310			8240*	6270	7523
4.5m					12990*	12990*	9900*	8640	8470*	6170			7970	5390	8151
3m							11000*	8150	8880	5940			7370	4950	8467
1.5m							11760*	7770	8650	5730			7200	4810	8506
0m					15700*	11470	11840	7580	8520	5610			7420	4930	8273
- 1.5m					14560*	11530	11340*	7550	8520	5610			8160	5390	7741
- 3m			14810*	14810*	12550*	11730	9820	7690					8190*	6480	6842
- 4.5m					8820*	8820*							7170*	7170*	5388

**LIFT CAPACITIES – Dipper length: 2.63m, Boom: 6.45m, Trackshoes: 600mm triple grouser. JS330 LC MONO**

Load Point	Reach from Swing Centre														
	1.5m		3m		4.5m		6m		7.5m		9m		Max Reach		
															
Height	kg	kg	kg	kg	kg	kg	kg	kg	kg	kg	kg	kg	kg	kg	mm
7.5m													7960*	7230	7008
6m							8530*	8530*	7810*	6430			7720*	5770	7972
4.5m					12240*	12240*	9520*	8800	8180*	6250			7420	5030	8567
3m					14820*	12400	10690*	8290	8730*	6010			6910	4650	8867
1.5m					14130*	11680	11600*	7870	8710	5780			6760	4520	8905
0m					16070*	11460	11890	7620	8540	5630			6940	4620	8682
- 1.5m			11800*	11800*	15140*	11480	11580*	7550	8490	5590			7540	5000	8178
- 3m			16800*	16800*	13380*	11650	10390*	7640					7950*	5860	7334
- 4.5m			12540*	12540*	10220*	10220*	7380*	7380*					7370*	7370*	6004

**LIFT CAPACITIES – Dipper length: 3.23m, Boom: 6.45m, Trackshoes: 600mm triple grouser. JS330 LC MONO**



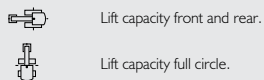











Load Point	Reach from Swing Centre														
	1.5m		3m		4.5m		6m		7.5m		9m		Max Reach		
															
Height	kg	kg	kg	kg	kg	kg	kg	kg	kg	kg	kg	kg	kg	kg	mm
7.5m										6740*	6580		5540*	5540*	7713
6m										7210*	6530		5350*	5140	8597
4.5m							8830*	8830*	7680*	6320	6540*	4680	5350*	4540	9150
3m					13720*	12750	10100*	8390	8320*	6040	6770	4560	5530*	4220	9432
1.5m					15630*	11850	11190*	7910	8710	5780	6630	4430	5890*	4100	9467
0m					16160*	11450	11780*	7600	8500	5590	6530	4340	6270	4170	9258
- 1.5m			11700*	11700*	15650*	11350	11720	7470	8400	5500			6730	4460	8788
- 3m			18510*	18510*	14270*	11450	10900*	7490	8380*	5530			7510*	5090	8009
- 4.5m			15240*	15240*	11720*	11720*	8880*	7690					7270*	6500	6815

















- Notes:**
- Lifting capacities are based on ISO 10567, that is: 75% of minimum tipping load or 87% of hydraulic lift capacity, whichever is the less. Lifting capacities marked\* are based on hydraulic capacity.
  - Lift capacities assume that the machine is on firm, level ground.
  - Lift capacities may be limited by local regulations. Please refer to your dealer.

















**LIFT CAPACITIES – Dipper length: 4.03m, Boom: 6.45m, Tracks: 600mm triple grouser. JS330 LC MONO**

Load Point	Reach from Swing Centre															
	1.5m		3m		4.5m		6m		7.5m		9m		Max Reach			
																
Height	kg	kg	kg	kg	kg	kg	kg	kg	kg	kg	kg	kg	kg	kg	mm	
9m														4890*	4890*	7396
7.5m														4550*	4550*	8586
6m									6520*	6520*	5990*	4930	4430*	4430*	9387	
4.5m									7080*	6520	6550*	4830	4450*	4080	9895	
3m					12310*	12310*	9350*	8710	7820*	6220	6900	4680	4590*	3820	10156	
1.5m					14730*	12320	10650*	8160	8550*	5930	6730	4510	4870*	3710	10189	
0m			7390*	7390*	15970*	11670	11540*	7760	8610	5680	6580	4380	5330*	3750	9995	
- 1.5m	7330*	7330*	11080*	11080*	16080*	11400	11800	7530	8440	5530	6490	4300	5960	3960	9562	
- 3m	11460*	11460*	15900*	15900*	15250*	11390	11440*	7460	8390	5480			6660	4410	8853	
- 4.5m	16330*	16330*	18410*	18410*	13390*	11560	10150*	7560	7600*	5590			7070*	5330	7792	
- 6m			13160*	13160*	9900*	9900*	7070*	7070*					6650*	6650*	6196	

**LIFT CAPACITIES – Dipper length: 2.21m, Boom: 6.45m, Tracks: 600mm triple grouser. JS330 NLC MONO**

Load Point	Reach from Swing Centre														
	1.5m		3m		4.5m		6m		7.5m		9m		Max Reach		
															
Height	kg	kg	kg	kg	kg	kg	kg	kg	kg	kg	kg	kg	kg	kg	mm
7.5m							8640*	8520					8580*	7440	6491
6m							8960*	8320	8240	5790			8240	5750	7523
4.5m					12990*	11990	9900*	7900	8470*	5650			7940	4930	8151
3m							11000*	7420	8840	5420			7340	4520	8467
1.5m							11760*	7050	8620	5220			7170	4380	8506
0m					15700*	10290	11790	6860	8480	5100			7390	4490	8273
- 1.5m					14560*	10350	11340*	6840	8480	5100			8120	4910	7741
- 3m			14810*	14810*	12550*	10550	9820*	6970					8190*	5890	6842
- 4.5m					8820*	8820*							7170*	7170*	5388





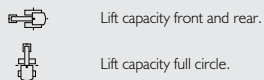









**LIFT CAPACITIES – Dipper length: 2.63m, Boom: 6.45m, Tracks: 600mm triple grouser. JS330 NLC MONO**

Load Point	Reach from Swing Centre															
	1.5m		3m		4.5m		6m		7.5m		9m		Max Reach			
																
Height	kg	kg	kg	kg	kg	kg	kg	kg	kg	kg	kg	kg	kg	kg	mm	
7.5m														7960*	6650	7008
6m							8530*	8480	7810*	5900			7720*	5300	7972	
4.5m					12240*	12240*	9520*	8050	8180*	5730			7390	4600	8567	
3m					14820*	11190	10690*	7560	8730*	5500			6880	4250	8867	
1.5m					14130*	10490	11600*	7150	8680	5270			6730	4120	8905	
0m					16070*	10280	11840	6910	8510	5120			6910	4200	8682	
- 1.5m			11800*	11800*	15140*	10300	11580*	6840	8460	5080			7500	4550	8178	
- 3m			16800*	16800*	13380*	10470	10390*	6920					7950*	5340	7334	
- 4.5m			12540*	12540*	10220*	10220*	7380*	7240					7370*	7240	6004	

















- Notes:**
- Lifting capacities are based on ISO 10567, that is: 75% of minimum tipping load or 87% of hydraulic lift capacity, whichever is the less. Lifting capacities marked\* are based on hydraulic capacity.
  - Lift capacities assume that the machine is on firm, level ground.
  - Lift capacities may be limited by local regulations. Please refer to your dealer.















**LIFT CAPACITIES – Dipper length: 3.23m, Boom: 6.45m, Trackshoes: 600mm triple grouser. JS330 NLC MONO**

Load Point	Reach from Swing Centre														
	1.5m		3m		4.5m		6m		7.5m		9m		Max Reach		
															
Height	kg	kg	kg	kg	kg	kg	kg	kg	kg	kg	kg	kg	kg	kg	mm
7.5m									6740*	6060			5540*	5540*	7713
6m									7210*	6000			5350*	4720	8597
4.5m							8830*	8180	7680*	5790	6540*	4280	5350*	4150	9150
3m					13720*	11530	10100*	7650	8320*	5520	6740	4160	5530*	3850	9432
1.5m					15630*	10650	11190*	7190	8680	5270	6600	4040	5890*	3730	9467
0m					16160*	10270	11780*	6880	8460	5080	6500	3940	6420	3790	9258
- 1.5m			11700*	11700*	15650*	10180	11670	6750	8360	4990			6700	4050	8788
- 3m			18510*	18510*	14270*	10270	10900*	6770	8380*	5020			7510*	4630	8009
- 4.5m			15240*	15240*	11720*	10540	8880*	6970					7270*	5910	6815

**LIFT CAPACITIES – Dipper length: 4.03m, Boom: 6.45m, Trackshoes: 600mm triple grouser. JS330 NLC MONO**

Load Point	Reach from Swing Centre														
	1.5m		3m		4.5m		6m		7.5m		9m		Max Reach		
															
Height	kg	kg	kg	kg	kg	kg	kg	kg	kg	kg	kg	kg	kg	kg	mm
9m													4890*	4890*	7396
7.5m													4550*	4550*	8586
6m									6520*	6220	5990*	4520	4430*	4170	9387
4.5m									7080*	5990	6550*	4430	4450*	3730	9895
3m					12310*	12180	9350*	7960	7820*	5700	6880	4280	4590*	3480	10156
1.5m					14730*	11110	10650*	7430	8550*	5410	6700	4120	4870*	3380	10189
0m			7390*	7390*	15970*	10480	11540*	7030	8570	5170	6550	3980	5330*	3410	9995
- 1.5m	7330*	7330*	11080*	11080*	16080*	10220	11750	6810	8400	5020	6460	3900	5940	3590	9562
- 3m	11460*	11460*	15900*	15900*	15250*	10210	11440*	6750	8360	4980			6630	4000	8853
- 4.5m	16330*	16330*	18410*	18410*	13390*	10380	10150*	6840	7600*	5080			7070*	4850	7792
- 6m			13160*	13160*	9900*	9900*	7070*	7070*					6650*	6650*	6196

**LIFT CAPACITIES – Dipper length: 2.21m, Boom: 6.1m, Trackshoes: 600mm triple grouser. JS330 LC ME**



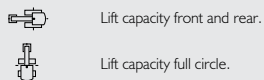











Load Point	Reach from Swing Centre														
	1.5m		3m		4.5m		6m		7.5m		9m		Max Reach		
															
Height	kg	kg	kg	kg	kg	kg	kg	kg	kg	kg	kg	kg	kg	kg	mm
7.5m							9290*	9230					9300*	9030	6073
6m							9310*	9140					8830*	6830	7166
4.5m					12920*	12920*	10140*	8780	8830*	6230			8580	5820	7824
3m							11190*	8340	8990	6050			7900	5330	8152
1.5m							11960*	7980	8790	5860			7720	5180	8193
0m					16160*	11740	12050	7780	8670	5760			7990	5340	7950
- 1.5m			15470*	15470*	14880*	11780	11430*	7750					8760*	5890	7396
- 3m			15210*	15210*		12500	11990	9470*	7910				8400	7220	6447

















**Notes:**

- Lifting capacities are based on ISO 10567, that is: 75% of minimum tipping load or 87% of hydraulic lift capacity, whichever is the less. Lifting capacities marked\* are based on hydraulic capacity.
- Lift capacities assume that the machine is on firm, level ground.
- Lift capacities may be limited by local regulations. Please refer to your dealer.















**LIFT CAPACITIES – Dipper length: 2.63m, Boom: 6.1m, Trackshoes: 600mm triple grouser. JS330 LC ME**

Load Point	Reach from Swing Centre														
	1.5m		3m		4.5m		6m		7.5m		9m		Max Reach		
															
Height	kg	kg	kg	kg	kg	kg	kg	kg	kg	kg	kg	kg	kg	kg	mm
7.5m							8580*	8580*					7710*	7710*	6615
6m							8830*	8830*	8270*	6430			7310*	6240	7630
4.5m					12190*	12190*	9730*	8930	8500*	6320			7270*	5400	8250
3m					14740*	12820	10880*	8470	8990*	6120			7370	4990	8562
1.5m					16310*	12060	11800*	8070	8840	5910			7210	4850	8601
0m					16420*	11770	12110	7820	8690	5770			7430	4980	8370
- 1.5m			14940*	14940*	15460*	11750	11720*	7750	8660	5740			8140	5430	7846
- 3m			17220*	17220*	13430*	11920	10230*	7850					8180*	6470	6960
- 4.5m					9520*	9520*							7220*	7220*	5538

**LIFT CAPACITIES – Dipper length: 2.21m, Boom: 6.1m, Trackshoes: 600mm triple grouser. JS330 NLC ME**

Load Point	Reach from Swing Centre														
	1.5m		3m		4.5m		6m		7.5m		9m		Max Reach		
															
Height	kg	kg	kg	kg	kg	kg	kg	kg	kg	kg	kg	kg	kg	kg	mm
7.5m							9290*	8480					9300*	8300	6073
6m							9310*	8400					8830*	6270	7166
4.5m					12920*	12330	10140*	8830*	5720				8540	5330	7824
3m							11190*	7610	8950	5530			7870	4880	8152
1.5m							11960*	7250	8750	5350			7690	4730	8193
0m					16160*	10550	12000	7060	8630	5250			7690	4870	7950
- 1.5m			15470*	15470*	14880*	10600	11430*	7030					8760*	5370	7396
- 3m			15210*	15210*	12500*	10800	9470	7190					8400*	6570	6447





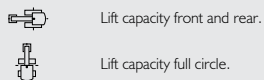









**LIFT CAPACITIES – Dipper length: 2.63m, Boom: 6.1m, Trackshoes: 600mm triple grouser. JS330 NLC ME**

Load Point	Reach from Swing Centre														
	1.5m		3m		4.5m		6m		7.5m		9m		Max Reach		
															
Height	kg	kg	kg	kg	kg	kg	kg	kg	kg	kg	kg	kg	kg	kg	mm
7.5m							8580*	8580*					7710*	7310	6615
6m							8830*	8540	8270*	5910			7310*	5730	7630
4.5m					12190*	12190*	9730*	8190	8500*	5800			7270*	4950	8250
3m					14740*	11600	10880*	7740	8990*	5600			7340	4560	8562
1.5m					16310*	10860	11800*	7340	8810	5400			7180	4430	8601
0m					16420*	10580	12060	7100	8650	5260			7400	4540	8370
- 1.5m			14940*	14940*	15460*	10570	11720*	7030	8620	5230			8110	4950	7846
- 3m			17220*	17220*	13430*	10730	10230*	7130					8180*	5890	6960
- 4.5m					9520*	9520*							7220*	7220*	5538

















- Notes:**
- Lifting capacities are based on ISO 10567, that is: 75% of minimum tipping load or 87% of hydraulic lift capacity, whichever is the less. Lifting capacities marked\* are based on hydraulic capacity.
  - Lift capacities assume that the machine is on firm, level ground.
  - Lift capacities may be limited by local regulations. Please refer to your dealer.















**LIFT CAPACITIES – Dipper length: 2.21m, Boom: 6.45m, Trackshoes: 600mm triple grouser. JS360 LC MONO**

Load Point	Reach from Swing Centre														
	1.5m		3m		4.5m		6m		7.5m		9m		Max Reach		
															
Height	kg	kg	kg	kg	kg	kg	kg	kg	kg	kg	kg	kg	kg	kg	mm
7.5m							9990*	9990*					9920*	9240	6498
6m							10380*	10340	9540*	7210			9530*	7170	7523
4.5m					15020*	15020*	11460*	9840	9810*	7040			9380	6170	8146
3m							12710*	9280	10350*	6780			8690	5680	8457
1.5m							13580*	8850	10170	6550			8490	5520	8492
0m					18080*	13050	13740*	8630	10020	6410			8760	5660	8253
- 1.5m					16750*	13130	13080*	8610	10020	6410			9650	6200	7715
- 3m			17020*	17020*	14420*	13370	11310*	8770					9510	7450	6806
- 4.5m					10100*	10100*							8330*	8330*	5334

**LIFT CAPACITIES – Dipper length: 2.63m, Boom: 6.45m, Trackshoes: 600mm triple grouser. JS360 LC MONO**

Load Point	Reach from Swing Centre														
	1.5m		3m		4.5m		6m		7.5m		9m		Max Reach		
															
Height	kg	kg	kg	kg	kg	kg	kg	kg	kg	kg	kg	kg	kg	kg	mm
7.5m													9170*	8240	7006
6m							9810*	9810*	9000*	7300			8910*	6570	7965
4.5m					14080*	14080*	10960*	9950	9420*	7090			8700	5730	8555
3m					17070*	14020	12300*	9370	10050*	6800			8100	5290	8852
1.5m							13340*	8890	10170	6540			7920	5150	8884
0m					18460*	13000	13710*	8620	9980	6370			8140	5260	8657
- 1.5m			14240*	14240*	17380*	13020	13300*	8540	9930	6320			8860	5690	8146
- 3m			19260*	19260*	15330*	13210	11900*	8650					9200*	6690	7292
- 4.5m					11640*	11640*							8530*	8530*	5945





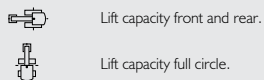









**LIFT CAPACITIES – Dipper length: 3.23m, Boom: 6.45m, Trackshoes: 600mm triple grouser. JS360 LC MONO**

Load Point	Reach from Swing Centre														
	1.5m		3m		4.5m		6m		7.5m		9m		Max Reach		
															
Height	kg	kg	kg	kg	kg	kg	kg	kg	kg	kg	kg	kg	kg	kg	mm
7.5m										7870*	7480		6630*	6630	7704
6m										8290*	7400		6410*	5850	8584
4.5m							10170*	10120	8840*	7150	7610*	5300	6430*	5160	9134
3m					15790*	14430	11620*	9500	9570*	6840	7910	5160	6660*	4800	9412
1.5m					17960*	13410	12860*	8950	10180	6540	7740	5010	7120*	4660	9443
0m					18540*	12960	13520*	8600	9940	6320	7620	4900	7360	4740	9229
- 1.5m			14080*	14080*	17940*	12860	13440*	8450	9820	6220			7900	5070	8753
- 3m			21920*	21920*	16340*	12980	12480*	8480	9590*	6260			8680*	5810	7965
- 4.5m			17390*	17390*	13390*	13310	10140*	8710					8430*	7450	6757

















- Notes:**
- Lifting capacities are based on ISO 10567, that is: 75% of minimum tipping load or 87% of hydraulic lift capacity, whichever is the less. Lifting capacities marked\* are based on hydraulic capacity.
  - Lift capacities assume that the machine is on firm, level ground.
  - Lift capacities may be limited by local regulations. Please refer to your dealer.















**LIFT CAPACITIES – Dipper length: 4.03m, Boom: 6.45m, Tracks: 600mm triple grouser. JS360 LC MONO**

Load Point	Reach from Swing Centre															
	1.5m		3m		4.5m		6m		7.5m		9m		Max Reach			
																
Height	kg	kg	kg	kg	kg	kg	kg	kg	kg	kg	kg	kg	kg	kg	mm	
9m														5570*	5570*	7419
7.5m														5160*	5160*	8601
6m									7350*	7350*	6770*	5470		5010*	5010*	9396
4.5m									7980*	7240	7380*	5340		5020*	4490	9900
3m					13900*	13900*	10540*	9660	8810*	6880	7790*	5150		5170*	4190	10157
1.5m					16630*	13630	12000*	9000	9630*	6520	7690	4950		5490*	4070	10185
0m			8770*	8770*	18020*	12880	12990*	8530	9860	6230	7510	4780		5990*	4100	9988
- 1.5m	8670*	8670*	13160*	13160*	18120*	12580	13310*	8260	9660	6050	7410	4690		6830	4330	9549
- 3m	13590*	13590*	18910*	18910*	17150*	12570	12850*	8200	9610	6010				7640	4840	8835
- 4.5m	19430*	19430*	20660*	20660*	15010*	12790	11370*	8320	8490*	6150				7930*	5890	7766
- 6m			14590*	14590*	10990*	10990*	7800*	7800*						7420*	7420*	6156

**LIFT CAPACITIES – Dipper length: 2.21m, Boom: 6.45m, Tracks: 600mm triple grouser. JS360 NLC MONO**

Load Point	Reach from Swing Centre															
	1.5m		3m		4.5m		6m		7.5m		9m		Max Reach			
																
Height	kg	kg	kg	kg	kg	kg	kg	kg	kg	kg	kg	kg	kg	kg	mm	
7.5m							9990*	9740						9920*	8490	6498
6m							10380*	9500	9540*	6620				9530*	6590	7523
4.5m					15020*	13630	11460*	9000	9810*	6460				9360	5660	8146
3m							12710*	8450	10350*	6200				8660	5190	8457
1.5m							13580*	8030	10140	5970				8470	5030	8492
0m					18080*	11720	13740*	7820	9990	5830				8740	5160	8253
- 1.5m					16750*	11790	13080*	7800	10000	5840				9620	5640	7715
- 3m			17020*	17020*	14420*	12020	11310*	7960						9510*	6790	6806
- 4.5m					10100*	10100*								8330*	8330*	5334





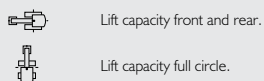









**LIFT CAPACITIES – Dipper length: 2.63m, Boom: 6.45m, Tracks: 600mm triple grouser. JS360 NLC MONO**

Load Point	Reach from Swing Centre															
	1.5m		3m		4.5m		6m		7.5m		9m		Max Reach			
																
Height	kg	kg	kg	kg	kg	kg	kg	kg	kg	kg	kg	kg	kg	kg	mm	
7.5m														9170*	7580	7006
6m							9810*	9610	9000*	6700				8910*	6040	7965
4.5m					14080*	13690	10960*	9110	9420*	6500				8680	5240	8555
3m					17070*	12650	12300*	8540	10050*	6220				8080	4840	8852
1.5m							13340*	8080	10150	5960				7900	4690	8884
0m					18460*	11670	13710*	7810	9960	5790				8120	4790	8657
- 1.5m			14240*	14240*	17380*	11690	13300*	7740	9900	5750				8840	5180	8146
- 3m			19260*	19260*	15330*	11870	11900*	7840						9200*	6090	7292
- 4.5m					11640*	11640*								8530*	8310	5945

















- Notes:**
- Lifting capacities are based on ISO 10567, that is: 75% of minimum tipping load or 87% of hydraulic lift capacity, whichever is the less. Lifting capacities marked\* are based on hydraulic capacity.
  - Lift capacities assume that the machine is on firm, level ground.
  - Lift capacities may be limited by local regulations. Please refer to your dealer.















**LIFT CAPACITIES – Dipper length: 3.23m, Boom: 6.45m, Trackshoes: 600mm triple grouser. JS360 NLC MONO**

Load Point	Reach from Swing Centre														
	1.5m		3m		4.5m		6m		7.5m		9m		Max Reach		
															
Height	kg	kg	kg	kg	kg	kg	kg	kg	kg	kg	kg	kg	kg	kg	mm
7.5m									7870*	6880			6630*	6540	7704
6m									8290*	6810			6410*	5370	8584
4.5m							10170*	9270	8840*	6560	7610*	4850	6430*	4720	9134
3m					15790*	13050	11620*	8660	9570*	6250	7880	4710	6660*	4380	9412
1.5m					17960*	12060	12860*	8130	10160	5960	7720	4570	7120*	4240	9443
0m					18540*	11620	13520*	7790	9910	5740	7600	4460	7340	4310	9229
- 1.5m			14080*	14080*	17940*	11530	13440*	7640	9800	5640			7880	4610	8753
- 3m			21920*	21920*	16340*	11640	12480*	7670	9590*	5680			8680*	5280	7965
- 4.5m			17390*	17390*	13390*	11960	10140*	7900					8430*	6780	6757

**LIFT CAPACITIES – Dipper length: 4.03m, Boom: 6.45m, Trackshoes: 600mm triple grouser. JS360 NLC MONO**

Load Point	Reach from Swing Centre														
	1.5m		3m		4.5m		6m		7.5m		9m		Max Reach		
															
Height	kg	kg	kg	kg	kg	kg	kg	kg	kg	kg	kg	kg	kg	kg	mm
9m													5570*	5570*	7419
7.5m													5160*	5160*	8601
6m									7350*	6930	6770*	5010	5010*	4610	9396
4.5m									7980*	6650	7380*	4890	5020*	4100	9900
3m					13900*	13530	10540*	8820	8810*	6290	7790*	4700	5170*	3810	10157
1.5m					16630*	12270	12000*	8180	9630*	5930	7670	4500	5490*	3690	10185
0m			8770*	8770*	18020*	11540	12990*	7710	9830	5650	7490	4340	5990*	3720	9988
- 1.5m	8670*	8670*	13160*	13160*	18120*	11250	13310*	7450	9630	5470	7390	4250	6810	3920	9549
- 3m	13590*	13590*	18910*	18910*	17150*	11240	12850*	7390	9590	5430			7620	4390	8835
- 4.5m	19430*	19430*	20660*	20660*	15010*	11460	11370*	7510	8490*	5570			7930*	5340	7766
- 6m			14590*	14590*	10990*	10990*	7800*	7800*					7420*	7420*	6156





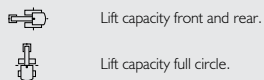









**LIFT CAPACITIES – Dipper length: 2.21m, Boom: 6.1m, Trackshoes: 600mm triple grouser. JS360 LC ME**

Load Point	Reach from Swing Centre														
	1.5m		3m		4.5m		6m		7.5m		9m		Max Reach		
															
Height	kg	kg	kg	kg	kg	kg	kg	kg	kg	kg	kg	kg	kg	kg	mm
7.5m							10720*	10540					10730*	10310	6075
6m							10770*	10430					10200*	7800	7163
4.5m					14930*	14930*	11720*	9990	10200*	7110			10030*		
3m							12910*	9470	10540	6890					
1.5m							13780*	9050	10310	6670					
0m					18550*	13300*	13930	8830	10170	6550					
- 1.5m			18720*	18720*	17070*	13360	13140*	8800							
- 3m			17380*	17380*	14300*	13610	10850*	9000							

















- Notes:**
- Lifting capacities are based on ISO 10567, that is: 75% of minimum tipping load or 87% of hydraulic lift capacity, whichever is the less. Lifting capacities marked\* are based on hydraulic capacity.
  - Lift capacities assume that the machine is on firm, level ground.
  - Lift capacities may be limited by local regulations. Please refer to your dealer.















**LIFT CAPACITIES – Dipper length: 2.63m, Boom: 6.45m, Tracks: 600mm triple grouser. JS360 LC ME**

Load Point	Reach from Swing Centre														
	1.5m		3m		4.5m		6m		7.5m		9m		Max Reach		
															
Height	kg	kg	kg	kg	kg	kg	kg	kg	kg	kg	kg	kg	kg	kg	mm
7.5m														9170*	7006
6m							9810*	9610	9000*	6700				8910*	7965
4.5m					14080*	13690	10960*	9110	9420*	6500				8680	8555
3m					17070*	12650	12300*	8540	10050*	6220				8080	8852
1.5m							13340*	8080	10150	5960				7900	8884
0m					18460*	11670	13710*	7810	9960	5790				8120	8657
- 1.5m			14240*	14240*	17380*	11690	13300*	7740	9900	5750				8840	8146
- 3m			19260*	19260*	15330*	11870	11900*	7840						9200*	7292
- 4.5m					11640*	11640*								8530*	5945

**LIFT CAPACITIES – Dipper length: 3.23m, Boom: 6.45m, Tracks: 600mm triple grouser. JS360 NLC MONO**

Load Point	Reach from Swing Centre														
	1.5m		3m		4.5m		6m		7.5m		9m		Max Reach		
															
Height	kg	kg	kg	kg	kg	kg	kg	kg	kg	kg	kg	kg	kg	kg	mm
7.5m									7870*	6880				6630*	7704
6m									8290*	6810				6410*	8584
4.5m							10170*	9270	8840*	6560	7610*	4850		6430*	9134
3m					15790*	13050	11620*	8660	9570*	6250	7880	4710		6660*	9412
1.5m					17960*	12060	12860*	8130	10160	5960	7720	4570		7120*	9443
0m					18540*	11620	13520*	7790	9910	5740	7600	4460		7340	9229
- 1.5m			14080*	14080*	17940*	11530	13440*	7640	9800	5640				7880	8753
- 3m			21920*	21920*	16340*	11640	12480*	7670	9590*	5680				8680*	7965
- 4.5m			17390*	17390*	13390*	11960	10140*	7900						8430*	6757

**LIFT CAPACITIES – Dipper length: 4.03m, Boom: 6.45m, Tracks: 600mm triple grouser. JS360 NLC MONO**

Load Point	Reach from Swing Centre														
	1.5m		3m		4.5m		6m		7.5m		9m		Max Reach		
															
Height	kg	kg	kg	kg	kg	kg	kg	kg	kg	kg	kg	kg	kg	kg	mm
9m														5570*	7419
7.5m														5160*	8601
6m									7350*	6930	6770*	5010		5010*	9396
4.5m									7980*	6650	7380*	4890		5020*	9900
3m					13900*	13530	10540*	8820	8810*	6290	7790*	4700		5170*	10157
1.5m					16630*	12270	12000*	8180	9630*	5930	7670	4500		5490*	10185
0m			8770*	8770*	18020*	11540	12990*	7710	9830	5650	7490	4340		5990*	9988
- 1.5m	8670*	8670*	13160*	13160*	18120*	11250	13310*	7450	9630	5470	7390	4250		6810	9549
- 3m	13590*	13590*	18910*	18910*	17150*	11240	12850*	7390	9590	5430				7620	8835
- 4.5m	19430*	19430*	20660*	20660*	15010*	11460	11370*	7510	8490*	5570				7930*	7766
- 6m			14590*	14590*	10990*	10990*	7800*	7800*						7420*	6156

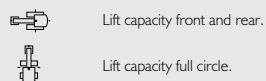

- Notes:**
- Lifting capacities are based on ISO 10567, that is: 75% of minimum tipping load or 87% of hydraulic lift capacity, whichever is the less. Lifting capacities marked\* are based on hydraulic capacity.
  - Lift capacities assume that the machine is on firm, level ground.
  - Lift capacities may be limited by local regulations. Please refer to your dealer.



**ONE COMPANY, OVER 300 MACHINES.**

Your nearest JCB dealer

**Hydraulic Excavator JS330/360 LC/NLC**

Net engine power: 210kW (281hp) Operating weight: 32029kg/38016kg

JCB Sales Limited, Rokeceter, Staffordshire, United Kingdom ST14 5JP.

Tel: +44 (0)1889 590312 Email: [salesinfo@jcb.com](mailto:salesinfo@jcb.com)

Download the very latest information on this product range at: [www.jcb.com](http://www.jcb.com)

©2009 JCB Sales. All rights reserved. No part of this publication may be reproduced, stored in a retrieval system, or transmitted in any form or by any other means, electronic, mechanical, photocopying or otherwise, without prior permission from JCB Sales. All references in this publication to operating weights, sizes, capacities and other performance measurements are provided for guidance only and may vary dependant upon the exact specification of machine. They should not therefore be relied upon in relation to suitability for a particular application. Guidance and advice should always be sought from your JCB Dealer. JCB reserves the right to change specifications without notice. Illustrations and specifications shown may include optional equipment and accessories. All images are correct at time of print. The JCB logo is a registered trademark of J C Bamford Excavators Ltd.



9999/5742 en-GB 03/14 Issue 1 (T2)

